

easYgen-600

Technical Manual | Genset Control



easYgen-600

Version 3.0.0.3

Document ID: B37698, Revision D - Build 53530

Manual (original)

This is no translation but the original Technical Manual in English.

Designed in Germany and Poland; manufactured in China.

Woodward GmbH

Handwerkstr. 29

70565 Stuttgart

Germany

Telephone: +49 (0) 711 789 54-510

Fax: +49 (0) 711 789 54-101

E-mail: marketing_pg@woodward.com

Internet: <http://www.woodward.com>

© 2023 Woodward GmbH. All rights reserved.

Brief Overview

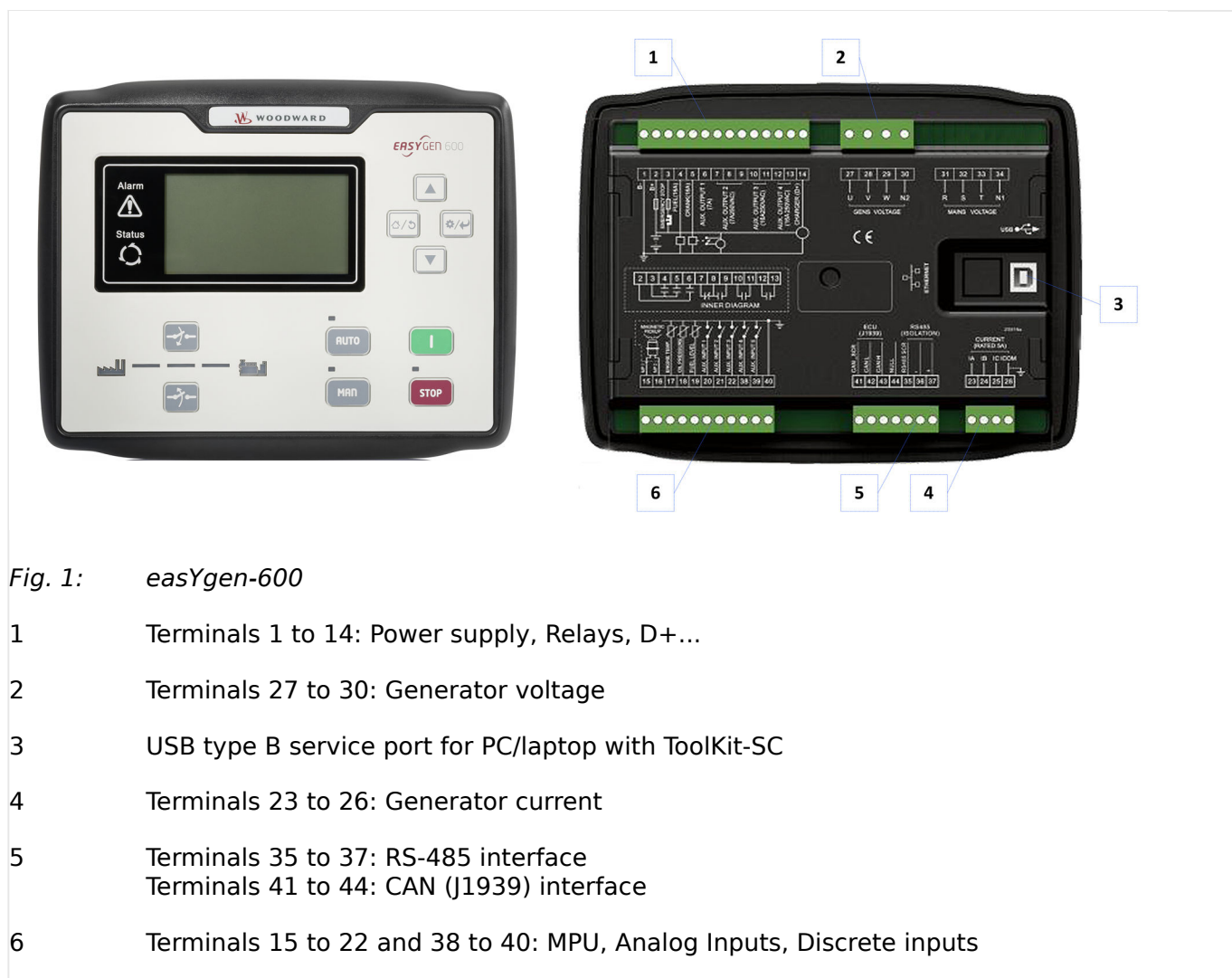

The easYgen-600 are control units for engine-generator management applications.

The control units can be used in simple Start/Stop applications.

Scope of delivery

The following parts are included in the covering box. Please check prior to the installation that all parts are present:

- Device easYgen genset control
 - All screwable terminal connectors are delivered with plug **and** jack
- Clamp fastener installation material (4x)
- »Installation Procedure Supplement« paper with links to the latest edition of Technical Documentation and software for download: (<http://wwdmanuals.com/easYgen-600>)

QR Code



To get access to the configuration software and the complete product documentation, scan this QR code or use the following link: ⇒ <http://wwdmanuals.com/easygen-600>.

Sample application setup

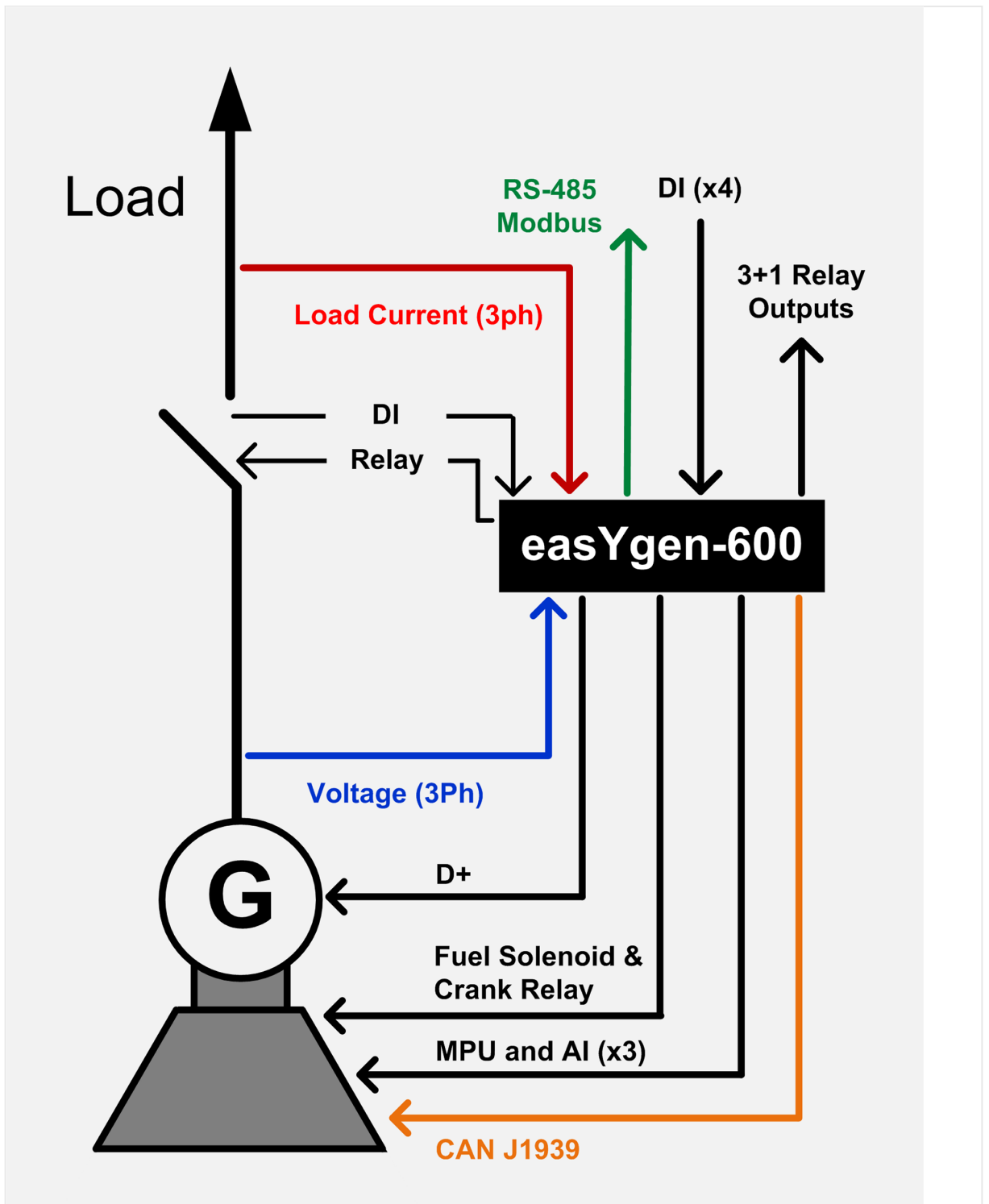

Fig. 2: Sample application setup

A typical application mode for the control unit is the use for non parallel operation in a single genset application.

- In this case, the easYgen will function as an engine control with generator and engine protection.
- The control unit can open and close the circuit breaker .

Brief Overview



Transition procedures are described in chapter [↳](#) “5.4 Transition Procedures”.

Table of Contents

1	General Information	10
1.1	About this Manual	10
1.1.1	Revision History	10
1.1.2	Symbols Used in this manual	11
1.2	Copyright And Disclaimer	12
1.3	Service And Warranty	13
1.4	Safety	13
1.4.1	Intended Use	13
1.4.2	Personnel	14
1.4.3	General hazard warnings	15
2	System Overview	16
2.1	Display and Status Indicators	16
2.2	Features and Functions of both easYgen-600 and -1600	17
2.3	Functions	19
3	Installation	21
3.1	Mounting	21
3.2	Wiring	21
3.3	Interfaces	28
3.4	Install ToolKit-SC	29
4	Configuration	30
4.1	Access to the Control	30
4.1.1	Front Panel: Operating and Display Elements	30
4.1.2	Front Panel Control	32
4.1.2.1	HMI Screens Without Password Level	33
4.1.3	Configure ToolKit-SC	35
4.1.3.1	Configure Communication	36
4.1.3.2	Manage Configuration Data	36
4.1.3.3	Select Language	36
4.1.4	Access via ToolKit-SC Configuration Tool	37

Table of Contents

4.2	Parameters	38
4.2.1	Parameter Menu Structure	38
4.2.2	Parameter Settings Menu--HMI Access	39
4.2.3	Configure Measurement	40
4.2.4	Configure Application	42
4.2.4.1	Configure Inputs and Outputs	42
4.2.4.2	Configure Engine	48
4.2.4.3	Configure TEST Run	51
4.2.4.4	Configure Breakers	52
4.2.5	Configure Monitoring	53
4.2.5.1	Monitoring Generator	53
4.2.5.2	Monitoring Breakers	55
4.2.5.3	Monitoring Engine	55
4.2.5.4	Other Monitoring	55
4.2.6	Configure Interfaces	56
4.2.7	Configure Maintenance	56
4.2.8	Configure Counters	57
4.2.9	Configure Language / Clock	57
4.2.10	Configure System Management	58
4.2.11	Configure HMI	58
4.3	Selectable Inputs/Outputs/Sensors	59
4.3.1	Programmable Sensors	59
4.3.2	Programmable Inputs	61
4.3.3	Programmable Outputs	62
4.4	Status Menu	63
4.4.1	HMI Status Screens	63
4.4.2	ToolKit-SC Status Screens	64
5	Operation	67
5.1	Warning/Alarm Signaling	67
5.1.1	Alarm Acknowledgment	67
5.2	Operation Modes	67
5.2.1	Operation Mode AUTO	68

5.2.2	Operation Mode MANual	68
5.2.3	Operation Mode STOP	68
5.3	START/STOP Operation	68
5.3.1	Start engine to supply load	69
5.3.2	Stop engine	70
5.3.3	MANual START/STOP	72
5.4	Transition Procedures	72
5.4.1	Disconnect during cranking	72
6	Commissioning	74
7	Interfaces and Protocols	75
7.1	J1939	75
8	Technical Specifications	81
8.1	Measuring and Monitoring	84
9	Appendix	86
9.1	Alarms and Warnings	86
9.1.1	Alarm Classes	86
9.1.2	Warnings	86
9.1.3	Shutdown Alarms	87
9.2	Trouble Shooting	88
9.3	Data Telegrams	89
9.3.1	General Information	89
9.3.2	Supported Function Codes	91
9.3.2.1	Function # 01 (01h) – Read COIL STATUS	91
9.3.2.2	Function # 03 (03h) – Read Holding Registers	92
9.3.2.3	Function # 05 (05h) – Force Single Coil	93
9.3.3	Function #1 Coil Status Map	94
9.3.4	Function #3 Register Map	98
9.3.5	Function #5 Remote coils Map	101
10	Glossary and List of Abbreviations	103
11	Index	104

1 General Information

1.1 About this Manual

1.1.1 Revision History

Rev.	Date	Editor	Changes
D	2023-08	MK	<p>NEW Software Version 3.0.0.3</p> <ul style="list-style-type: none"> • Suitable for new LCD display <p>Technical Manual</p> <ul style="list-style-type: none"> • Added wiring diagrams for generator voltage measurement ↪ “Generator Voltage Measuring” • Added QR code • Added engine types to parameter ↪ Table • Added AWG and torque rating
			<p>NEW Software Version 3.0.0.2</p> <p>Corrections/Repairs</p> <ul style="list-style-type: none"> • Oil pressure by J1939 now displayed • Corrected switchable frequency 50/60 Hz • Modified the ECU runtime timeout receive time • Engine type Cummins QSX15-CM570 added 0x04FF7EDC message (without this message the speed was unstable).
C	2021-12	MK	<p>Corrections/Repairs Technical Manual</p> <ul style="list-style-type: none"> • Corrected voltage range ph-N according to UL ↪ “8 Technical Specifications”. • Deleted 'pending' at EAC approval ↪ “8 Technical Specifications”. • Improved description at monitoring functions. • Updated download link.
A	2019-05	PW	<p>NEW Software Version 3.0.0.1 and ToolKit-SC Version 1.5.0.4</p> <p>Technical Manual</p> <ul style="list-style-type: none"> • In ↪ “3.2 Wiring”:<ul style="list-style-type: none"> ◦ terminal ratings and descriptions updated in ↪ Table ◦ corrections in ↪ Fig. 6 • Chapter ↪ “4.2.4.1 Configure Inputs and Outputs” supplemented with an external LED module • Minor adjustments of items in configuration menu descriptions • In ↪ “8 Technical Specifications” voltage ranges for the alternator and AC measurement updated to UL6200

Rev.	Date	Editor	Changes
			<ul style="list-style-type: none"> Added description of analog inputs in ↳ “8 Technical Specifications”
NEW	2018-03	GG	<p>Describes device implemented software version 2.4 and ToolKit-SC version 1.4.0.2</p> <p>Technical Manual</p> <ul style="list-style-type: none"> Release = 1st issue

1.1.2 Symbols Used in this manual

Safety instructions

Safety instructions are marked with symbols. The safety instructions are always introduced by signal words that express the severity of the danger.

DANGER!



This combination of symbol and signal word indicates an immediately dangerous situation that can cause death or severe injuries if not avoided.

WARNING!



This combination of symbol and signal word indicates a possibly dangerous situation that can cause death or severe injuries if it is not avoided.

CAUTION!



This combination of symbol and signal word indicates a possibly dangerous situation that can cause slight injuries if it is not avoided.

NOTICE!



This combination of symbol and signal word indicates a possibly dangerous situation that can cause property and environmental damage if it is not avoided.





Tips and recommendations



This symbol indicates useful tips and recommendations as well as information on efficient and trouble-free operation.

Additional markings

To highlight instructions, results, lists, references, and other elements, the following markings are used in these instructions:

Marking	Explanation
	Step-by-step instructions
	Results of action steps
	References to sections of these instructions and to other relevant documents
•	Listing without fixed sequence
»Buttons«	Operating elements (e.g. buttons, switches), display elements (e.g. signal lamps)
»Display«	Screen elements (e.g. buttons, programming of function keys)
[Screen xx / Screen xy / Screen xz] ...	Menu path. The following information and setting refer to a page on the HMI screen or ToolKit located as described here.
	Some parameters/settings/screens are available only either in ToolKit or on the HMI/display.



Dimensions in Figures

All dimensions with no units specified are in **mm**.

1.2 Copyright And Disclaimer

Disclaimer

All information and instructions in this manual have been provided under due consideration of applicable guidelines and regulations, the current and known state of the art, as well as our many years of in-house experience. Woodward assumes no liability for any damages due to:

- Failure to comply with the instructions in this manual
- Improper use / misuse
- Willful operation by non-authorized persons
- Unauthorized conversions or non-approved technical modifications
- Use of non-approved spare parts

The originator is solely liable for the full extent for damages caused by such conduct. The obligations agreed-upon in the delivery contract, the general terms and conditions, the manufacturer's delivery conditions, and the statutory regulations valid at the time the contract was concluded, apply.

Copyright

This manual is protected by copyright. No part of this manual may be reproduced in any form or incorporated into any information retrieval system without written permission of Woodward GmbH.

Delivery of this manual to third parties, duplication in any form - including excerpts - as well as exploitation and/or communication of the content, are not permitted without a written declaration of release by Woodward GmbH.

Actions to the contrary will entitle us to claim compensation for damages. We expressly reserve the right to raise any further accessory claims.

1.3 Service And Warranty

Opening the device will nullify any warranty!

CAUTION!



Any unauthorized modifications or use of this equipment outside its specified mechanical, electrical, or other operating limits may cause personal injury and/or property damage, including damage to the equipment.

Any such unauthorized modifications

- constitute "misuse" and/or "negligence" as per the product warranty
- thereby exclude warranty coverage for any resulting damage, and
- invalidate product certifications or listings.

Our Customer Service is available for technical information. Please see page 2 for contact details.

In addition, our employees are interested in any new information and experiences that arise from usage and could be valuable for improving our products.

Warranty terms



Please enquire about the terms of warranty from your nearest Woodward representative.

To find your closest Customer Service representative, go to:  <http://www.woodward.com/Directory.aspx>

1.4 Safety

1.4.1 Intended Use

The easYgen unit has been designed and constructed solely for the intended use described in this manual.

- Intended use requires operation of the control unit within the range outlined in the specifications listed in  "8 Technical Specifications".

1 General Information

1.4.2 Personnel

- Steps to be taken for commissioning are outlined in  “6 Commissioning”.
- Intended use includes compliance with all instructions and safety notes presented in this manual.
- Any use which exceeds or differs from the intended use shall be considered improper use.
- No claims for any kind for damage will be considered if such claims result from improper use.

NOTICE!***Damage due to improper use!***

Improper use of the remote panel unit may cause damage to the control unit as well as to the connected components.

Improper use includes, but is not limited to:

- Operation outside the specified operating conditions.

1.4.2 Personnel**WARNING!*****Hazards due to insufficiently qualified personnel!***

If unqualified personnel perform work on or with the control unit hazards may arise which can cause serious injury and substantial damage to property.

- Therefore, all work must only be carried out by appropriately qualified personnel.

This manual specifies the personnel qualifications required for the different areas of work, listed below:

- Well trained for electrical installations.
- Aware of the local safety regulations.
- Experienced in working with electronic measuring and control devices.
- Allowed to manage the controlled (engine/generator) system.

The workforce must only consist of persons who can be expected to carry out their work reliably. Persons with impaired reactions due to, for example, the consumption of drugs, alcohol, or medication are prohibited.

When selecting personnel, the age-related and occupation-related regulations governing the operating location must be observed.

1.4.3 General hazard warnings

Hazards by system controlled

DANGER!



Moving parts and dangerous electricity!

Be aware that the remote control of a system that is managing life-threatening engine-generator-electricity parts must be adapted to the local situation!

The following safety notes cover both the device itself and basics of the overall genset system. The dedicated genset-system safety instruction must be considered, too!

Prime mover safety

WARNING!



Hazards due to insufficient prime mover protection

The engine, turbine, or any other type of prime mover must be equipped with an overspeed (over-temperature, or over-pressure, where applicable) shutdown device(s) that operates independently of the prime mover control device(s) to protect from runaway or damage to the engine, turbine, or any other type of prime mover. Failure to comply with this also poses the risk of personal injury or loss of life if the mechanical-hydraulic governor(s) or electric control(s), the actuator(s), fuel control(s), the driving mechanism(s), the linkage(s), or the controlled device(s) fail.

2 System Overview

General notes

The easYgen is a stand-alone genset controller with measuring, monitoring, and breaker control functionality. It comes with an easily mountable plastic housing covering a thoroughly tested electronic-electrical system.

Display and buttons of the HMI offer access to states and values, as well as access to the application. Password protection enables the assignment of multiple operation access levels. Remote access, monitoring, visualization, and configuration are possible via integrated interfaces. Communication between easYgens using PLC control or as a network member offers an enhanced system management range; additionally supported by easy to implement accessories.



For even higher challenges in genset control, the easYgen series offers further solutions encompassing complex and ambitious applications.

For dedicated protection tasks, ask Woodward for its protection (relay) solutions.

Operation Modes

- See [↪](#) “5.2 Operation Modes”

2.1 Display and Status Indicators

General Notes

HMI and the configuration software enable access to control, settings, and visualization. The front panel offers a number of functionally defined buttons and a set of menu management buttons. LEDs visualize fixed states, the graphic display works together with the menu management buttons to show all necessary information.



Restrictions

Full access to all parameters and settings with configuration software only!

HMI access offers a number of information screens in general, and enables - password-protected - access to parameters and settings.



Fig. 3: easYgen-600

2.2 Features and Functions of both easYgen-600 and -1600

Both easYgen-600 and easYgen-1600 are very close in hardware and software. The easYgen-1600 is the device with more/higher functionality. For comparison and better differentiation both are described below.

easYgen-600 is intended to be used for single automation systems, auto start/stop of the unit are performed with the help of remote signal.

easYgen-1600 has all functions of easYgen-600 as well as automatic mains failure function (AMF), particularly well suited for single automation systems that include mains and generator.

Functional Blocks

Item		easYgen-600	easYgen-1600
LCD (with backlight)	Dimension	3.5"	3.5"
	Pixel	132 x 64	132 x 64
AMF		no	●
Digital input ports		5	5
Output ports		6	6
Sensors		3	3
Schedule function		●	●
RS485		●	●
J1939		●	●
USB (Type B)		●	●
Real-time clock		●	●

2 System Overview

2.2 Features and Functions of both easYgen-600 and -1600

Item	easYgen-600	easYgen-1600
Event log	●	●

Key characteristics

- With ARM-based 32-bit SCM, highly integrated hardware, high reliability level
- Multilingual interface (English, Chinese, Spanish, Russian, Portuguese, Turkish, Polish, and French) making commissioning convenient for factory personnel
- Improved LCD wear-resistance and scratch resistance due to hard screen acrylic
- Silicon panel and pushbuttons for better operation in high-temperature environment
- RS485 communication port enabling remote control, remote measuring, remote communication via ModBus protocol
- Equipped with CAN bus port to communicate with J1939 genset. Monitoring frequently-used data such as water temperature, oil pressure, speed, fuel consumption and so on of ECU machine, and additionally also control start, stop, raising speed, and speed droop via CAN bus port
- Suitable for 3-phase 4-wire, 3-phase 3-wire, single phase 2-wire, and 2-phase 3-wire systems with voltage 120/240 V and frequency 50/60 Hz
- **easYgen-1600 only:** Collects and shows 3-phase voltage, current, power parameter, and frequency of generator and additionally 3-phase mains voltage. Mains/Generator Line voltage (U_{AB} , U_{BC} , and U_{CA}), Phase voltage (U_A , U_B , and U_C).
- **easYgen-600 only:** Collects and shows 3-phase voltage, current, power parameter and frequency of generator. Generator Line voltage (U_{AB} , U_{BC} , and U_{CA}), Phase voltage (U_A , U_B , and U_C).
- Phase sequence, frequency, Load current I_A , I_B , I_C
- Each phase: Total active power [kW], Total reactive power [kvar], Total apparent power [kVA], Average power factor PF
- Accumulated Total generator power [kWh], [kvarh], [kVAh]
- **easYgen-1600 only:** For Mains, controller has over and under voltage, over and under frequency, loss of phase and phase sequence wrong detection functions
- For generator, controller has over and under voltage, over and under frequency, loss of phase, phase sequence wrong, over and reverse power, over current functions
- 3 fixed analog sensors: Engine temperature, oil pressure, and fuel level
- Precision measure and display parameters about Engine, Temp. (WT) °C/°F both be displayed Oil pressure (OP) kPa/psi/bar all be displayed Fuel level (FL) %(unit) Speed (SPD) r/min (unit) Battery Voltage (VB) V (unit) Charger Voltage (VD) V (unit) Hour count (HC) can accumulate to max. 65535 hours. Start times can accumulate to max. 65535 times
- Protection: automatic start/stop of the genset
- **easYgen-1600 only:** ATS (Auto Transfer Switch) control with perfect failure indication and protection function

- All output ports are relay-out
- Parameter setting: parameters can be modified and stored in internal FLASH memory and cannot be lost even in case of power outage; most of them can be adjusted using front panel of the controller and all of them can be modified using ToolKit-SC configuration software on PC via USB or RS485 port
- More kinds of curves of temperature, oil pressure, fuel level can be used directly and users can define the sensor curves by themselves
- Multiple crank disconnect conditions (generator frequency, speed sensor, oil pressure) are optional
- Widely power supply range DC (8 to 35) V, suitable to different start battery voltage environment
- Event log, real-time clock, scheduled start & stop generator (can be set as start genset once a day/week/month whether with load or not)
- Logon wallpaper and display time are user-defined
- Can be used on pumping units and as an indicating instrument (indicate and alarm are enable only, relay is inhibited)
- With maintenance function. Actions (warning or shutdown) can be set when maintenance time out
- All parameters are digital adjusted (instead of conventional analog modulation with normal potentiometer) for more reliability and stability
- Waterproof security level IP55 due to rubber seal installed between the controller enclosure and front panel
- Metal fixing clips enable perfect in high temperature environment
- Modular design, self-extinguishing ABS plastic enclosure, pluggable connection terminals and embedded installation way; compact structure with easy mounting
- Users can reset total run time and total electric energy for convenience.
- Users can customize Start-up screen (text/image)
- Users can define HMI status screens (content) via drag-and-drop

2.3 Functions

- Protection: automatic start/stop of the genset, ATS (Auto Transfer Switch) control with failure indication and protection function
- All output ports are relay-out
- Parameter settings: parameters can be modified and stored in internal FLASH memory and cannot be lost even in case of a power outage; most of them can be adjusted using front panel of the controller and all of them can be modified using ToolKit-SC on a PC via USB or RS485 ports.
- Temperature, oil pressure and fuel level curves can be used directly and users can define the sensor curves by themselves.

2 System Overview

2.3 Functions

- Multiple crank disconnect conditions (generator frequency, speed sensor, oil pressure) are optional.
- Event log, real-time clock, scheduled start & stop generator (can be set as start genset once a day/week/month with or without load).
- Start-up logo and display time are user-defined.
- Can be used on pumping units and as an indicating instrument (indicate and alarm are enable only, relay is inhibited).
- Maintenance function: Actions (warning or shutdown) can be set when maintenance time out.
- Instead of conventional analog modulation with a potentiometer, all parameters use digital adjustment for more reliability and stability.
- Accumulative total run time and total electric energy of A and B. The user can reset it to 0 and re-accumulate the value, which allows to count the total value.

3 Installation

3.1 Mounting

Fix the controller unit using the included clips. Please see below for the overall dimensions of the controller and the cutout dimensions of the panel.



Tighten the clips (tightening torque 0.3 Nm [2.65 lb·in]) in order to achieve the IP65 degree of protection.

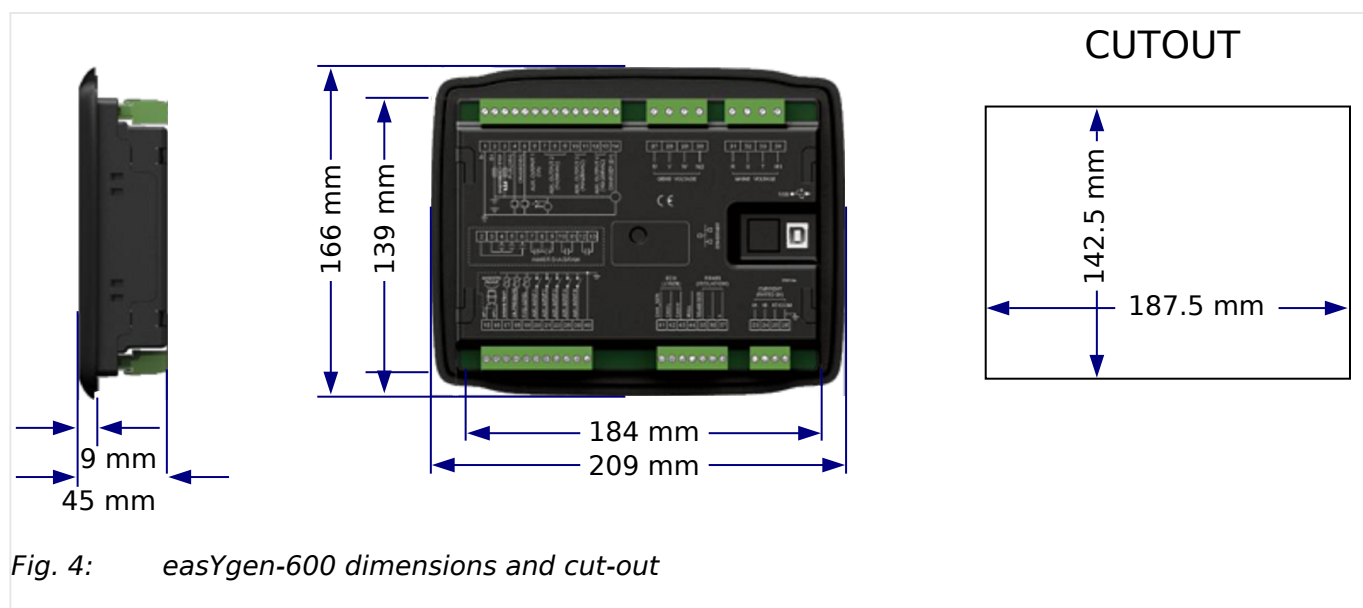

3.2 Wiring

General Notes



Battery Voltage Input

This controller can be used with batteries with a voltage range from 8 to 35 V_{DC}.

The negative pole of the battery must be connected to the engine shell. The wire between the power supply and the battery must have a cross section above 2.5 mm².

If floating charge is configured: To prevent the controller from disturbing charges, do the following:

- Directly connect the output wires of the charger to the positive and negative poles of the battery.
- Connect the wires from the positive and negative pole of the battery to the positive and negative input ports of the controller.

3 Installation

3.2 Wiring

**Speed Sensor Input**

Connect the two signal wires to terminals 15 and 16. The output voltage of speed sensor should be within 1 to 24 V_{eff} . 12 V_{eff} is recommended for rated speed.

CAUTION!**Digital (Relays) Outputs**

To prevent the controller from damage:

For DC current relays: Attach freewheeling diodes at both ends of relay's coils.

For AC current relays: Increase resistance of the return circuit of the relays coils.



Current input of controller must be connected to the outside of the current transformer (secondary side current is 5 A). Phases of current transformer and input voltage must be correct. Otherwise, the current of collecting power and active power maybe not correct.

I_{COM} port terminal 26 must be connected to negative pole of battery.

WARNING!

If there is a load current, opening the circuit of the output side of the transformer is not allowed!

CAUTION!**Withstand Voltage Test**

Disconnect all terminal connections before performing a high-voltage test of the installed controller.

CAUTION!

All inputs and outputs besides the Generator Voltage and Mains Voltage terminals of each model shall only be connected to limited voltage circuits from the engine starting battery protected by a maximum 2 A DC rated fuse.



- Use min. 90°C copper conductors only
- Recommended locked torque: 4 inch pounds / 0.5 Nm

AWG	mm ²	AWG	mm ²	AWG	mm ²	AWG	mm ²	AWG	mm ²	AWG	mm ²
30	0.05	21	0.38	14	2.5	4	25	3/0	95	600MCM	300

AWG	mm ²	AWG	mm ²	AWG	mm ²	AWG	mm ²	AWG	mm ²	AWG	mm ²
28	0.08	20	0.5	12	4	2	35	4/0	120	750MCM	400
26	0.14	18	0.75	10	6	1	50	300MCM	150	1000MCM	500
24	0.25	17	1.0	8	10	1/0	55	350MCM	185		
22	0.34	16	1.5	6	16	2/0	70	500MCM	240		

Table 1: Conversion chart - wire sizes

Terminals

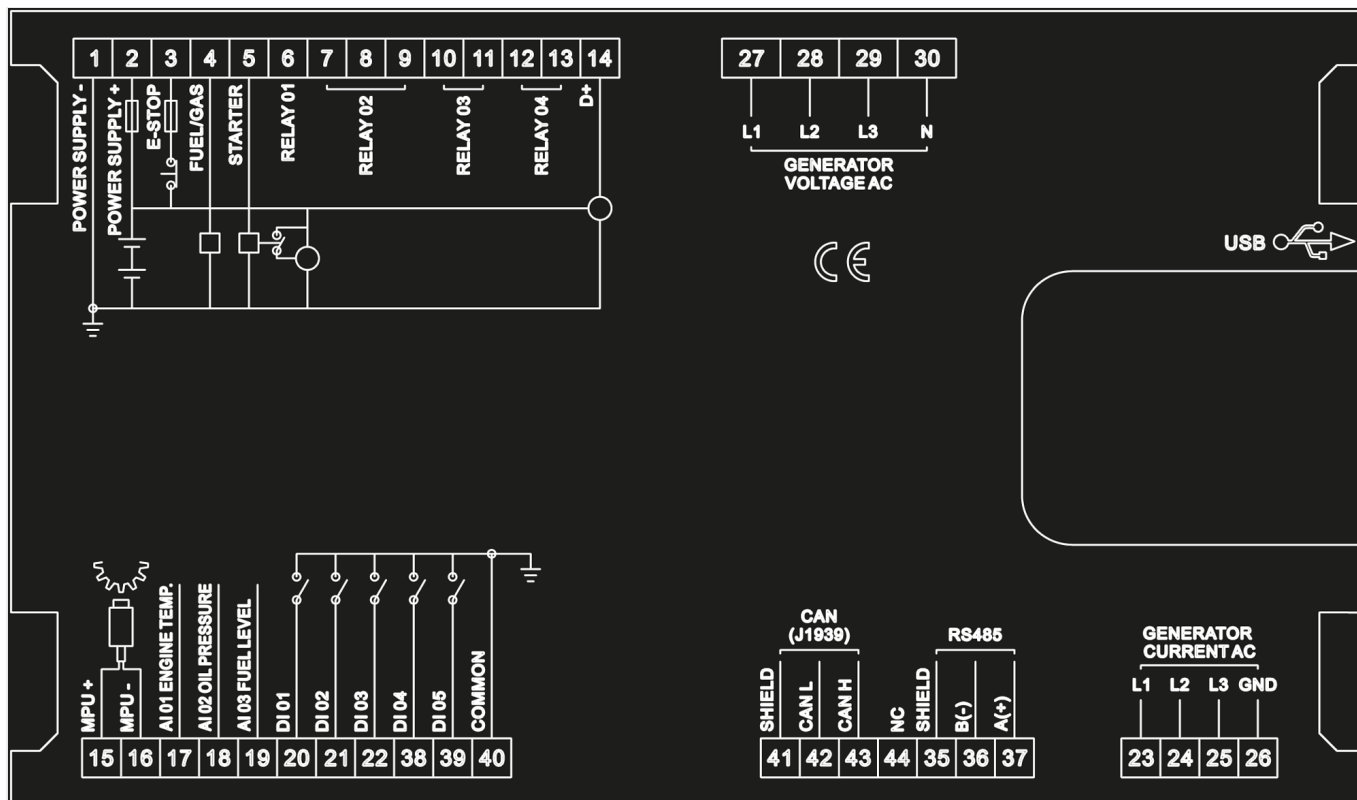

Fig. 5: easYgen 600 Terminals

No.	Function	Cable Size	Remarks
1	POWER SUPPLY -	2.5 mm ²	Connected with negative of starter battery
2	POWER SUPPLY +	2.5 mm ²	Connected to positive pole of starter battery. If the wire is longer than 30 m, use double wires in parallel. LPS, Class 2, LVLE, Listed DC fuse 4 A for 24 Vdc circuits is recommended.
3	E-STOP	2.5 mm ²	Connected with B+ via emergency stop button
4	FUEL/GAS	1.5 mm ²	Rated 10A _{dc} , 24V _{dc} running stand alone, rated 5A _{dc} , 24V _{dc} when running in parallel with the STARTER relay

3 Installation

3.2 Wiring

No.	Function	Cable Size	Remarks
			Relay is supplied by terminal 3, rated 2 Adc 24 Vdc, inductive (according to UL6200)
5	STARTER	1.5 mm ²	Rated 10Adc, 24Vdc running stand alone, rated 5Adc, 24Vdc when running in parallel with the FUEL/GAS relay Relay is supplied by terminal 3, rated 2 Adc 24 Vdc, inductive (according to UL6200)
6	Aux. Relay Output 1	1.5 mm ²	Relay is supplied by terminal 2, rated 7 Adc 28 Vdc, resistive GP (according to UL6200)
7	Aux. Relay Output 2	1.5 mm ²	Rated 7Adc, 24Vdc running stand alone, rated 3Adc, 24Vdc when running in parallel with RELAY 01 and RELAY 03 Normally closed output, 7 Aac 250 Vac voltage free output, resistive GP
8	Aux. Relay Output 2	1.5 mm ²	Rated 7Adc, 24Vdc running stand alone, rated 3Adc, 24Vdc when running in parallel with RELAY 01 and RELAY 02 Relay common port
9	Aux. Relay Output 2	1.5 mm ²	Normally open output, 7 Aac 250 Vac voltage free output, resistive GP
10	Aux. Relay Output 3	2.5 mm ²	Relay normally open, 10 Aac 250 Vac voltage free output, resistive GP
11	Aux. Relay Output 3	2.5 mm ²	Relay common port
12	Aux. Relay Output 4	2.5 mm ²	Relay normally open, 10 Aac 250 Vac voltage free output, resistive GP
13	Aux. Relay Output 4	2.5 mm ²	Relay common port
14	Charging Generator D+ Input	1.0 mm ²	Connect to D+ (WL) terminal. If without, the terminal is not connected.
15	MPU+	0.5 mm ²	Connected with speed sensor
16	MPU-	0.5 mm ²	Connected with speed sensor. A connection to B- is provided already internally.

Details see [↩](#)
[“4.3.3 Programmable Outputs”](#)

Note:If no MPU is installed, parameter "Firing speed RPM" ([PARAMETER / Configure application /

No.	Function	Cable Size	Remarks
			Configure engine / Configure start/ stop]) must be disabled: ↩ Table .
17	Temp. Sensor Input	1.0 mm ²	Connect to water / cylinder temp. resistance type sensor
18	Oil Pressure Sensor Input	1.0 mm ²	Connect to oil pressure resistance type sensor. Connect to oil pressure resistance.
19	Liquid Level Sensor Input	1.0 mm ²	Connect to liquid level resistance type sensor. Connect to liquid level resistance.
20	Configurable Input 1	1.0 mm ²	Ground connected is active (B–)
21	Configurable Input 2	1.0 mm ²	Ground connected is active (B–)
22	Configurable Input 3	1.0 mm ²	Ground connected is active (B–)
23	CT A Phase Sensing Input	1.5 mm ²	Connect secondary coil, rated 5 A
24	CT B Phase Sensing Input	1.5 mm ²	
25	CT C Phase Sensing Input	1.5 mm ²	
26	CT Common port	1.5 mm ²	Refer to Installation description
27	Generator U phase Voltage Sensing Input	1.0 mm ²	Connect to U phase output (2 A fuse is recommended)
28	Generator V phase Voltage Sensing Input	1.0 mm ²	Connect to V phase output (2 A fuse is recommended)
29	Generator W phase Voltage Sensing Input	1.0 mm ²	Connect to W phase output (2 A fuse is recommended)
30	Generator N2 Input	1.0 mm ²	Connect to generator N-wire
35	RS485 Common Ground	/	Empty terminal
36	RS485 –	0.5 mm ²	Impedance-120 Ω shielding wire is recommended, its single-end connect with ground
37	RS485+	0.5 mm ²	

3 Installation

3.2 Wiring

No.	Function	Cable Size	Remarks	
38	Configurable Input 4	1.0 mm ²	Impedance-120 Ω shielding wire is recommended, its single-end grounded	Details see ↪ “4.3.2 Programmable Inputs”
39	Configurable Input 5	1.0 mm ²		
40	Sensor Common	1.0 mm ²	Sensor common port	
41	CAN COM	/	Empty terminal	
42	CAN L	0.5 mm ²	Impedance-120 Ω shielding wire is recommended, its single-end connect with ground.	
43	CAN H	0.5 mm ²		
44	NC	0.5 mm ²	Empty terminal	

Wiring typical applications

Fig. 6: easYgen-600 wiring of a typical application

Generator Voltage Measuring

Setting '3Ph 4W' (3-phase, 4-wire)

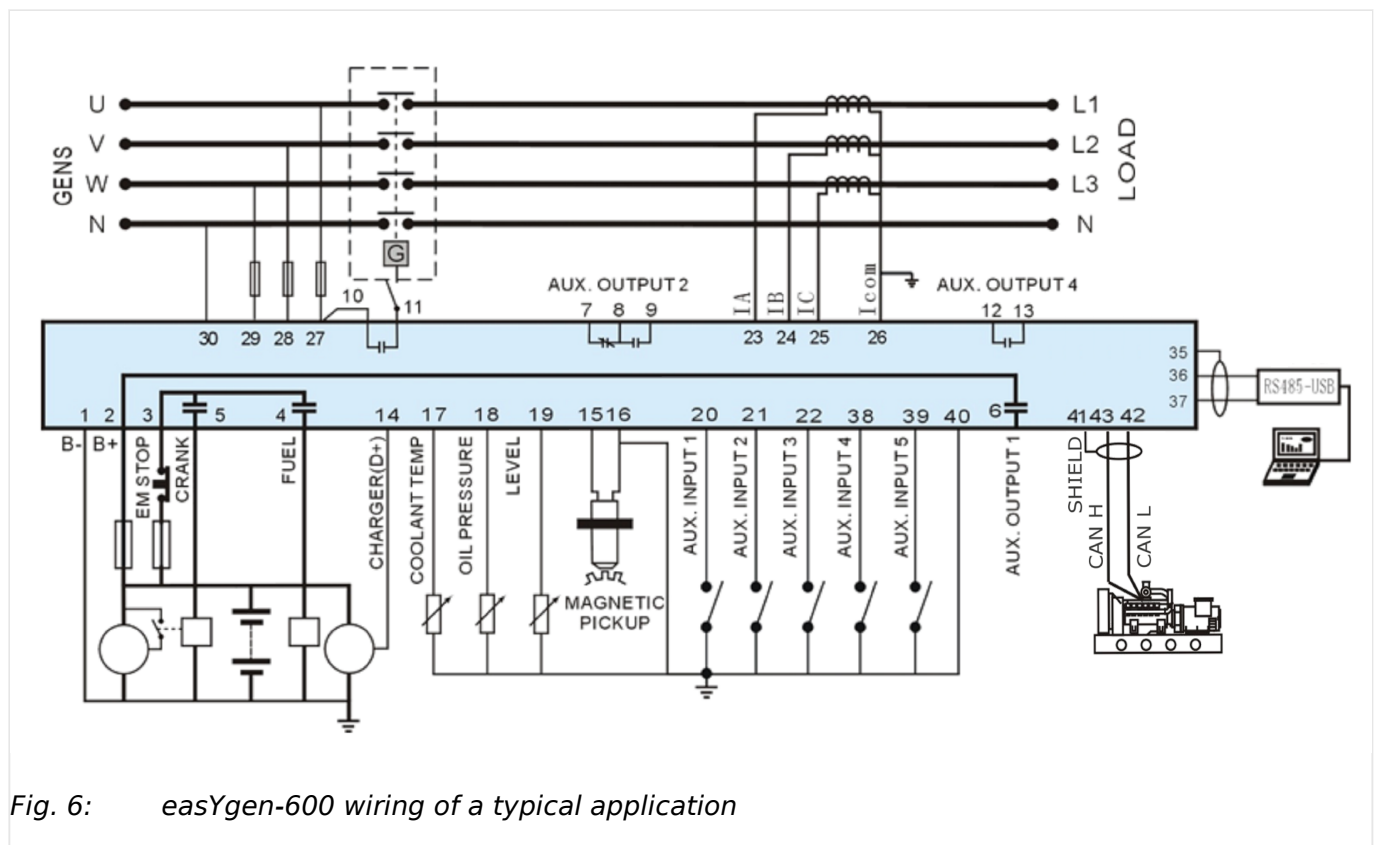
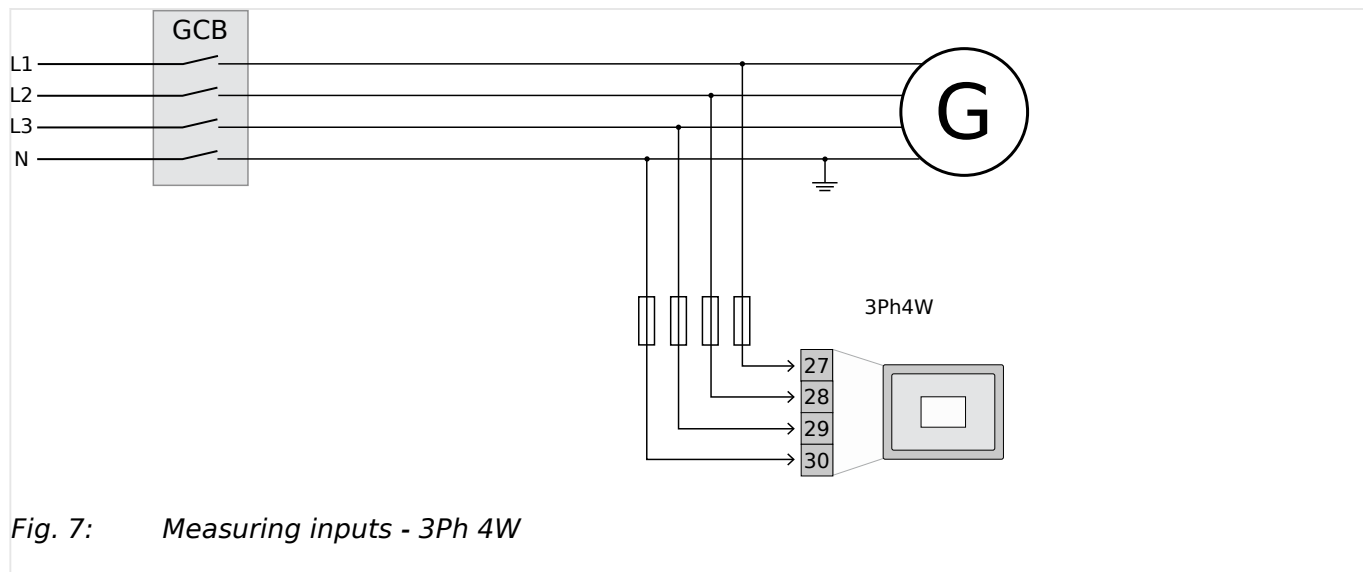

Setting '3Ph 3W' (3-phase, 3-wire)

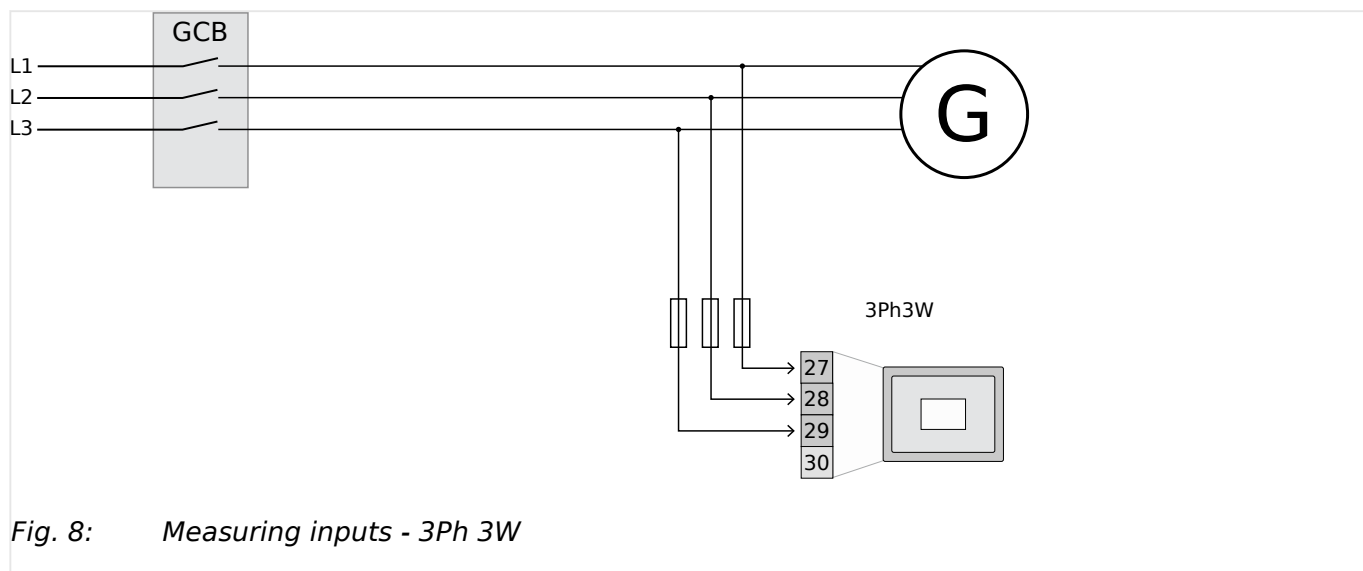

Setting '2Ph 3W' (2-phase, 3-wire)

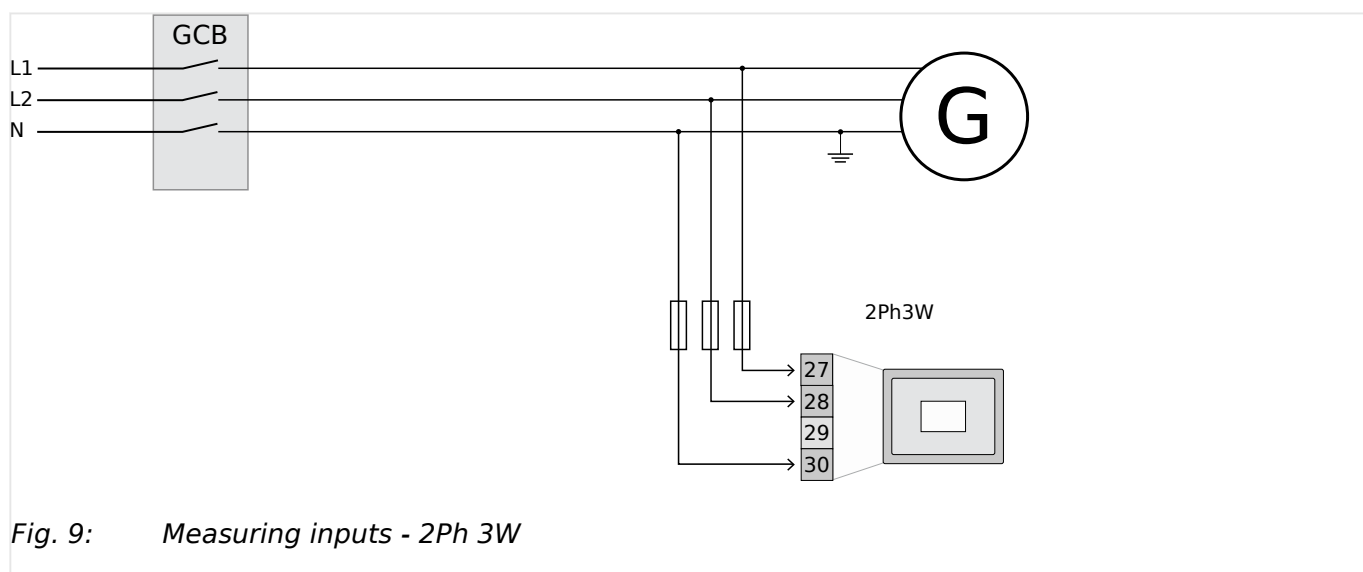

3 Installation
3.3 Interfaces

Setting '1Ph 2W' (1-phase, 2-wire) - phase-neutral

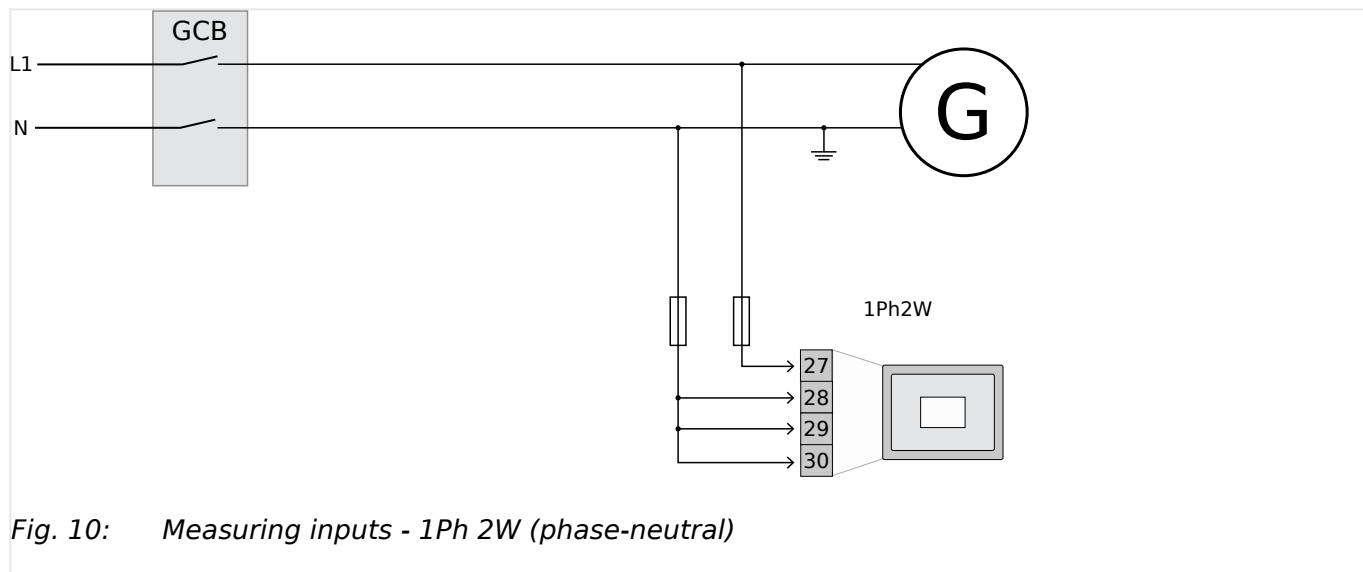

Fig. 10: Measuring inputs - 1Ph 2W (phase-neutral)

3.3 Interfaces

Interface Connections

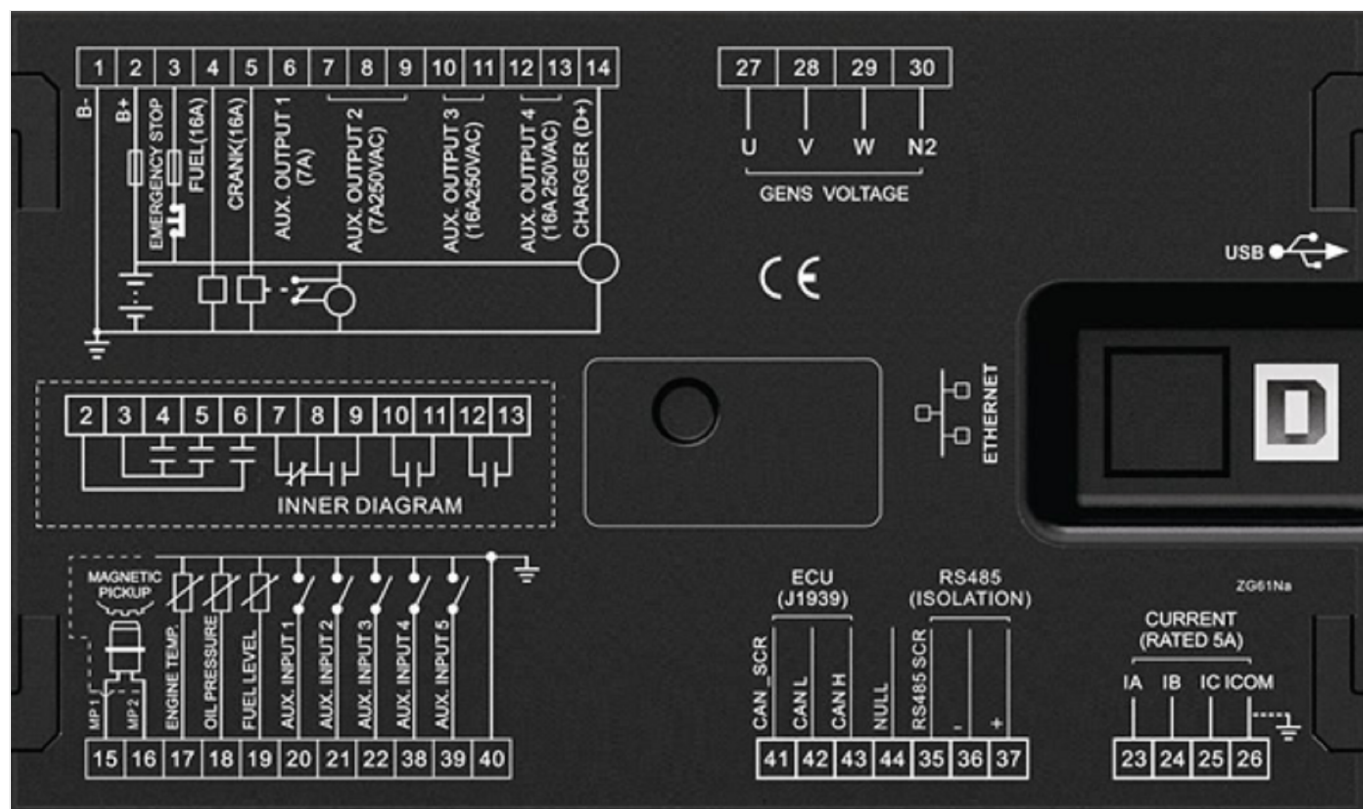

Fig. 11: Interface Connections

Interfaces	Intended use	Remarks
RS-485	For Remote Control via Modbus	For details, see 8

Interfaces	Intended use	Remarks
J1939	Engine communication J1939 and others	Technical Specifications”
USB	Configuration tool »ToolKit-SC« access only!	

3.4 Install ToolKit-SC

General notes

ToolKit-SC is a software tool for configuration including configuration file management, monitoring, remote control, and custom language management. The ToolKit-SC.exe file is available as a download on the Woodward website and the device-specific download website.

Please follow installation instruction.



Remove old software version(s) before update!

Make sure your custom configuration and language pack(s) are saved in a separate directory!

Prior to the installation of the new ToolKit-SC software, all older versions of the ToolKit-SC software must be un-installed.

4 Configuration

CAUTION!



Only change controller parameters in standby mode! Otherwise, abnormal conditions including shutdown may occur.

Configuration can be performed via

- HMI using front panel buttons
- USB connected PC/laptop using ToolKit-SC configuration software (full edit)

The configuration software ToolKit-SC is part of the delivery and (latest edition) can be downloaded from our website Woodward.com. Search for "ToolKit-SC".



Different digital/relay outputs can be configured with the same output type .

E.g.: Contents Setting of Flexible Output Port 1 is Output Type #18 "Horn". So #18 "Horn" can still be used for other Output ports, too.



Input the sensor curve: X values (resistor) must be arranged increasing from small to large, otherwise, an error occurs.

If selected sensor type is "None", the sensor curve is not working.

If a sensor has an alarm switch only, the release condition of this sensor must be configured as "Never", otherwise, a warning displays or a shutdown can occur.

4.1 Access to the Control

4.1.1 Front Panel: Operating and Display Elements







Fig. 12: easYgen-600

Icons	Keys	Description
	STOP	<p>Auto/Manual mode: Stop running generator</p> <p>Stop mode: Reset alarm</p> <p>Lamp test (press at least 3 seconds)</p> <p>Notes</p> <p>During stopping process, press this button again to stop generator immediately.</p>
	I (START)	MANual mode: Start genset
	MAN (Manual Mode)	Press this key and controller enters into MANual mode
	AUTO (Automatic Mode)	Press this key and controller enters into AUTO mode
	Up/Increase	<p>1) Screen scroll</p> <p>2) Setting menu: Up cursor and increase value in</p>
	Down/Decrease	<p>1) Screen scroll</p> <p>2) Settings menu: Down cursor and decrease value</p>
	Left	1) Settings menu: Left move cursor
	Exit	2) Settings menu: returns to the previous menu



4 Configuration

4.1.2 Front Panel Control

Icons	Keys	Description
		3) Returns to the home page
	Right Set/Confirm	2) Settings menu: Right move cursor 3) Returns to the main menu
	Alarm	
	Status	
	Genset	
	Load	



In MANual mode:

Pressing  and  (START) simultaneously will force the generator to crank. Successful start will not be judged according to crank disconnect conditions, the operator needs to crank the starter motor manually; Once the engine has fired, the operator must release the button. Only then the start output will be deactivated, safety on delay will start.

WARNING!



Users can change passwords. Please make note of the new password after changing it. If you forget the password, please contact Woodward services and send all device information on the "ABOUT" page of the controller for legitimation.

4.1.2 Front Panel Control

General Notes



Buttons below the screen/display have specific functions that are described in ["5 Operation"](#).

The configuration via front panel is limited to the current code level and restricted due to the editing/input possibilities of different buttons. Full access to all configuration options is only available when using the configuration (software) tool.

Navigation buttons allow for selection of a dedicated menu screen and the increase/decrease, next/previous, and enter commands.



On main menu (top) level:

1. ▷ Use next or previous button to switch to next or previous screen
2. ▷ Jump to main screen with ↻ button
3. ▷ Press and hold the ENTER button for more than three seconds.
 - ▶ The main menu opens.



In main menu buttons work like typical button managed inputs do:

1. ▷ Use down/decrease and up/increase button to select item/screen.
2. ▷ Enter using the ↵ button.
3. ▷ Use down/decrease and up/increase button to select item
4. ▷ To select several items: Use next (or previous) button(s) to select item.
5. ▷ ... Enter with ↵ and repeat steps 4. and 5. as often as required.
6. ▷ Make sure that your latest input was entered.
7. ▷ Go back to the upper level using the ↻ button
8. ▷ Repeat step 7. as often as required until you reach the main menu screen.

4.1.2.1 HMI Screens Without Password Level

General Notes

The main screen displays an overview over values, modes, messages and states. Two additional LEDs to the left of the display flash to indicate an alarm or the running of the system.

The up and down buttons let you scroll to the other screens in a loop:

- Home screen
- Status
- Engine
- Generator
- Load
- Alarm
- Home screen etc.

The first screen includes:

- Gen: voltage, frequency, current, active power, reactive power
- Engine: speed, temperature, oil pressure, battery voltage
- Other states

2nd screen includes:

- Status* of genset and breakers

4 Configuration

4.1.2.1 HMI Screens Without Password Level



*) This easYgen control model has no mains states and so no mains status screen

3rd screen includes:

- Speed, engine temperature, engine oil pressure, fuel level, auxiliary analog 1, auxiliary analog 2, battery voltage, charger voltage, accumulated run time, accumulated start times, user's total run time A, user's total run time B.
- **If connected with an J1939 engine via CANBUS port only:** coolant pressure, coolant level, fuel temperature, fuel pressure, inlet temperature, exhaust temperature, turbo pressure, fuel consumption, total fuel consumption and so on.

(Different engine with different parameters)

4th screen includes:

- Phase voltage, line voltage, frequency, phase sequence

5th screen includes:

- Current, active power (positive and negative), total active power (positive and negative), reactive power (positive and negative), total reactive power (positive and negative), apparent power, total apparent power,
- power factor (positive and negative), average power factor (positive and negative),
- accumulated energy,
- earth current,
- total electric energy A and B.

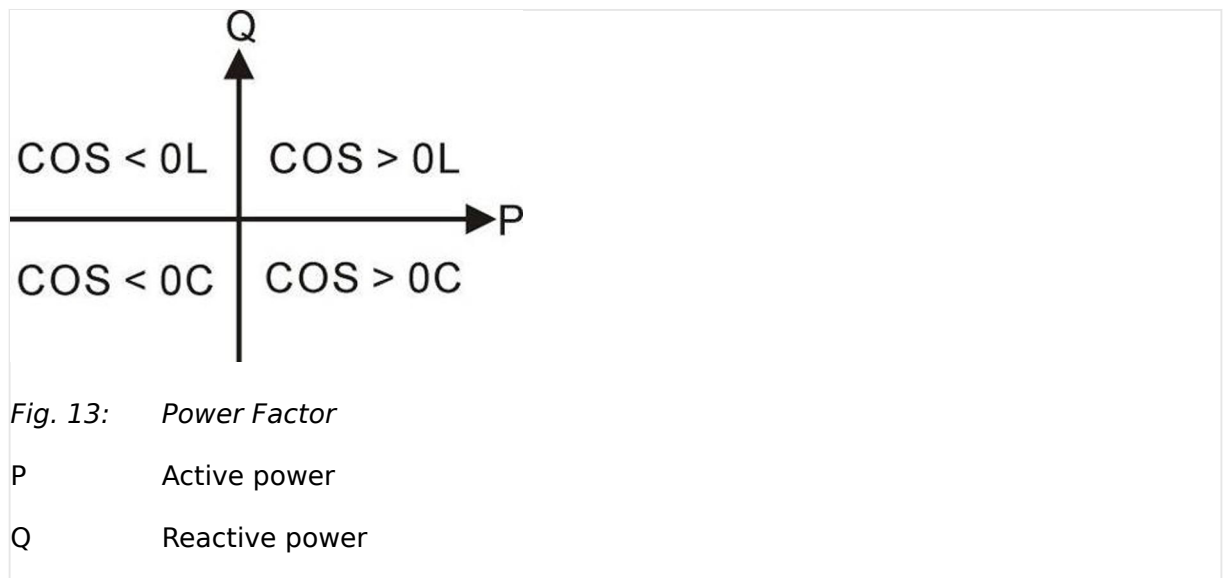

Power factor	Conditions	Active power	Reactive power	Remark
COS>0L	P>0, Q>0	Positive	Positive	Positive inductive load

Power factor	Conditions	Active power	Reactive power	Remark
COS>0C	P>0, Q<0	Positive	Negative	Positive capacitive load
COS<0L	P<0, Q>0	Negative	Positive	Negative inductive load
COS<0C	P<0, Q<0	Negative	Negative	Negative capacitive load



*) This easYgen control model has no mains states and so no mains status screen

6th screen includes:

- Display all alarm information e.g.,
warning alarm, shutdown alarm, trip alarm, and trip and stop alarm.



ECU alarms and shutdown alarms:

If the alarm information is displayed, check the engine, otherwise, please check the manual of the generator for the respective SPN alarm code.



Screens

Some screens are only visible in configuration mode. Press »Set/Confirm« button to switch to configuration mode.

Screens in configuration mode:

- 1 Set parameters
- 2 Information
- 3 Set language
- 4 Event log
- 5 ECU DM2
- 6 Maintenance

4.1.3 Configure ToolKit-SC



After ToolKit-SC has been started, it tries to connect to the last device that has been connected. If the setup has not changed, the values and settings of the device are read and the visualization is updated.

4 Configuration

4.1.3.1 Configure Communication

The lower status bar shows the current status of the connection and if there is a warning.

4.1.3.1 Configure Communication

Make sure that the connection hardware and your laptop/PC settings are correct.

»COM:« offers the following connections:

- USB
- COM*



*Com connection collects each RS-232 connection of your laptop/PC and makes it available for selection.

Refresh the connection using the »Refresh COM« button.

4.1.3.2 Manage Configuration Data

Configuration file handling:

- Save with [File / Save Config Strg+S]
- Select the default configuration (factory settings) with [File / New Config / [device name]]
- Load a configuration into ToolKit-SC with [File / Open Config Strg+O]
- Print the current configuration (to your default printer) with [File / Print Config]



Refresh config!

A configuration update between ToolKit-SC and the device (and vice versa) requires pushing the button »Read config« or »Write config«!

4.1.3.3 Select Language

General notes

ToolKit-SC can display English, Chinese, or Traditional Chinese. These languages can be selected from the »Language« menu.

The easYgen device can use one of eight pre-set languages: English, Chinese, Spanish, Russian, Portuguese, Turkish, Polish, French. The display language is changed once the configuration has been written to the device.



If a menu is open on the device while you change the language in ToolKit, the new language will display after pressing a front panel button.

4.1.4 Access via ToolKit-SC Configuration Tool

ToolKit-SC Screen Overview

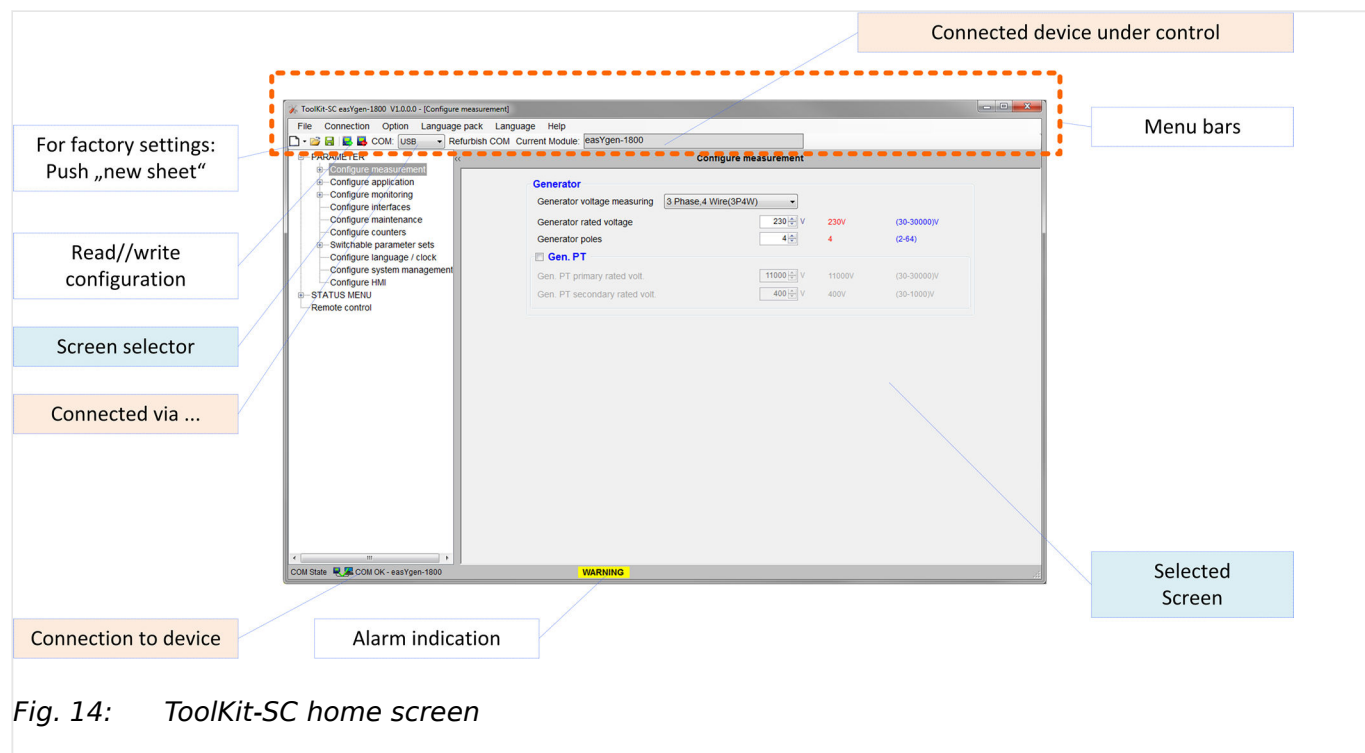

Fig. 14: ToolKit-SC home screen



1. ▷ Open ToolKit-SC on your computer.



ToolKit-SC is installed and connection between your computer and the easYgen device is established

- ▶ The ToolKit-SC home screen (see above) displays.
2. ▷ Click accept to read device configuration.
- ▶ ToolKit-SC displays the current device configuration settings and values.
3. ▷ Use the lower left area to select a screen/page to edit.
4. ▷ The button on the lower right side lets you select the screen.
5. ▷ To import your current ToolKit-SC configuration into the device, click on "Write config(W)" in the menu bar.



Your are asked to enter a password. Additionally, the splash screen image can be selected.

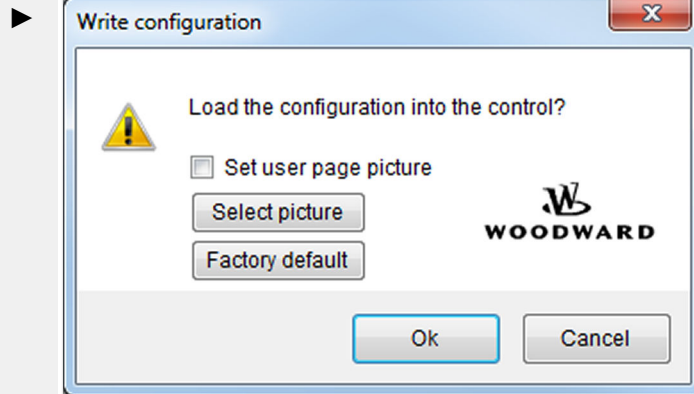

Fig. 15: ToolKit-SC: write configuration

The settings are transmitted to the device and immediately become active.

4.2 Parameters

4.2.1 Parameter Menu Structure

Parameter Menu



Parameters of both HMI (front panel access) and ToolKit-SC are not presented in the same order.

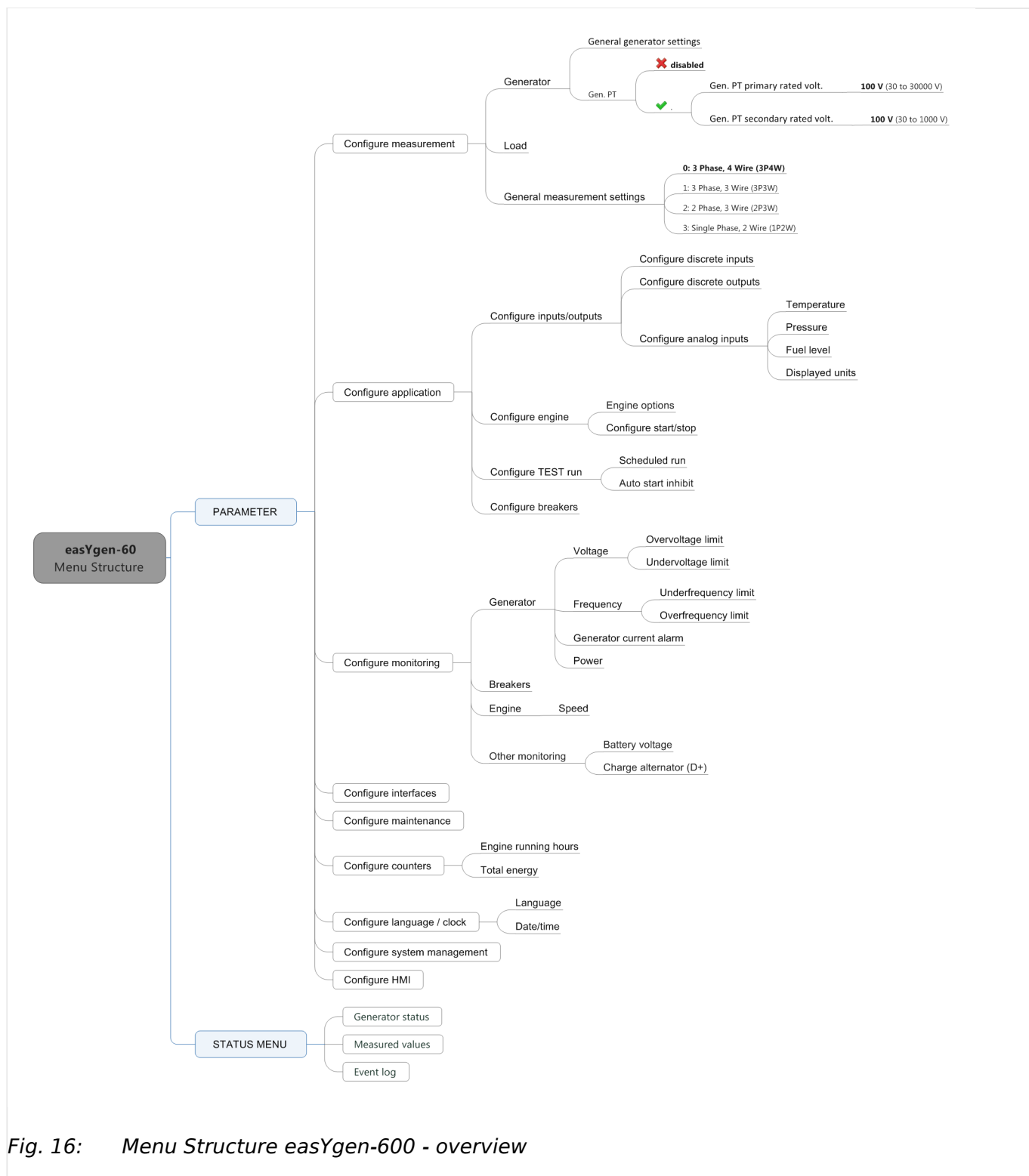

Fig. 16: Menu Structure easYgen-600 - overview

4.2.2 Parameter Settings Menu--HMI Access



1. ▷ Press the »RIGHT« button.

▶ The main menu opens.

4 Configuration

4.2.3 Configure Measurement

2. ▷ Select »1 set parameters«
3. ▷ Enter a password for the parameter settings screen.
4. ▷ Press return.



Factory default: 0500

- ▶ First parameter from the list appears.
5. ▷ Navigate until the desired parameter can be edited e.g. using the »Right« button
 6. ▷ Edit parameter.
 7. ▷ Press the »Set/Confirm« button
- ▶ The parameter is updated immediately!



The settings can be saved to the device by pressing the »Write« button!



The editor screen is closed automatically after five minutes of inactivity.



The setting process is aborted immediately when pushing the »Stop« button!

4.2.3 Configure Measurement

Generator Settings

[PARAMETER / Configure measurement / Generator]

Items	Parameters	Defaults	Description
General generator settings			
Monitoring	On Off	On	On Monitoring is enabled. Off Monitoring is disabled.
Generator poles	(2 to 64)	4	Number of generator poles. Used for calculating starter rotation speed if no speed sensor is used.
Generator fail delay time	(0.0 to 20.0) s	10.0 s	

Items	Parameters	Defaults	Description
Gen. PT	Unchecked: Disabled Checked: Enabled	Disabled	Notes Access to parameters below only if »enabled«
Gen. PT primary rated volt.	30 to 30000 V	100 V	Primary value from the used potential transformer (PT)
Gen. PT secondary rated volt.	30 to 1000 V	100 V	Secondary value from the used potential transformer (PT)

Load Settings

[PARAMETER / Configure measurement / Load]

Items	Parameters	Defaults	Description
Load			
Load CT primary rated current	(5 to 6000)/5	500/5	The ratio of external CT
Load rated current	(5 to 6000) A	500 A	Generator's rated current, standard of load current
Load percentage	Power (kW) / Power (kVA)	Power (kW)	Selects the reference for the Load %-value in Home Screen

General Measurement Settings

[PARAMETER / Configure measurement / General Measurement settings]

Items	Parameters	Defaults	Description
Voltage measuring			
Voltage measuring	0: 3 Phase, 4 Wire (3Ph4W) 1: 3 Phase, 3 Wire (3Ph3W) 2: 2 Phase, 3 Wire (2Ph3W) 3: Single Phase, 2 Wire (1Ph2W)	3 Phase, 4 Wire (3Ph4W)	3 Phase, 4 Wire (3Ph4W): The measurement is performed line-neutral and line-line: VL12, VL23 and VL31 VL1N, VL2N and VL3N 3 Phase, 3 Wire (3Ph3W) : The measurement is performed line-line. VL12, VL23 and VL31 2 Phase, 3 Wire (2Ph3W) The measurement is performed line-neutral and line-line: VL12 VL1N and VL2N Single Phase, 2 Wire (1Ph2W) The measurement is performed line-neutral: VL1N

4 Configuration

4.2.4 Configure Application

4.2.4 Configure Application

4.2.4.1 Configure Inputs and Outputs

4.2.4.1.1 Configure Discrete Inputs

Configure Discrete Inputs

[PARAMETER / Configure application / Configure discrete inputs]

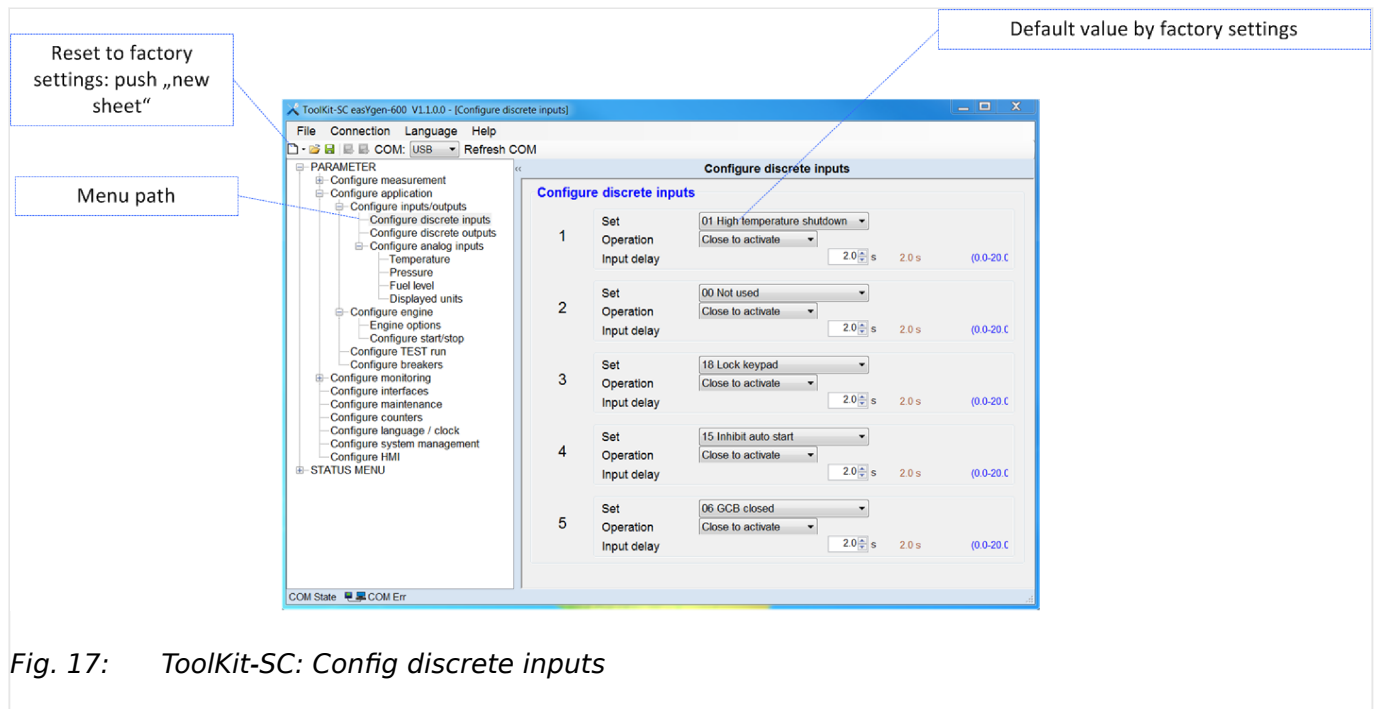

Fig. 17: ToolKit-SC: Config discrete inputs

Items	Parameters	Defaults	Description
Configure discrete inputs ...			
Set	00 to 23	01 High temperature shutdown	Default of discrete input 1
		02 Low oil pressure shutdown	Default of discrete input 2
		10 Start request in AUTO	Default of discrete input 3
		11 Fuel level warning	Default of discrete input 4
		12 Coolant level warning	Default of discrete input 5
		Notes	
Operation	Close to activate	Close to activate	Close to activate (N.O.): The discrete input is analyzed as "enabled" by energizing the input (normally open).

Items	Parameters	Defaults	Description
	Open to activate		Open to activate (N.C.): The discrete input is analyzed as "enabled" by de-energizing the input (normally closed).
Input delay	0.0 to 20.0 s	2.0 s	The input status must be valid for this period of time before it is released

4.2.4.1.2 Configure Discrete Outputs

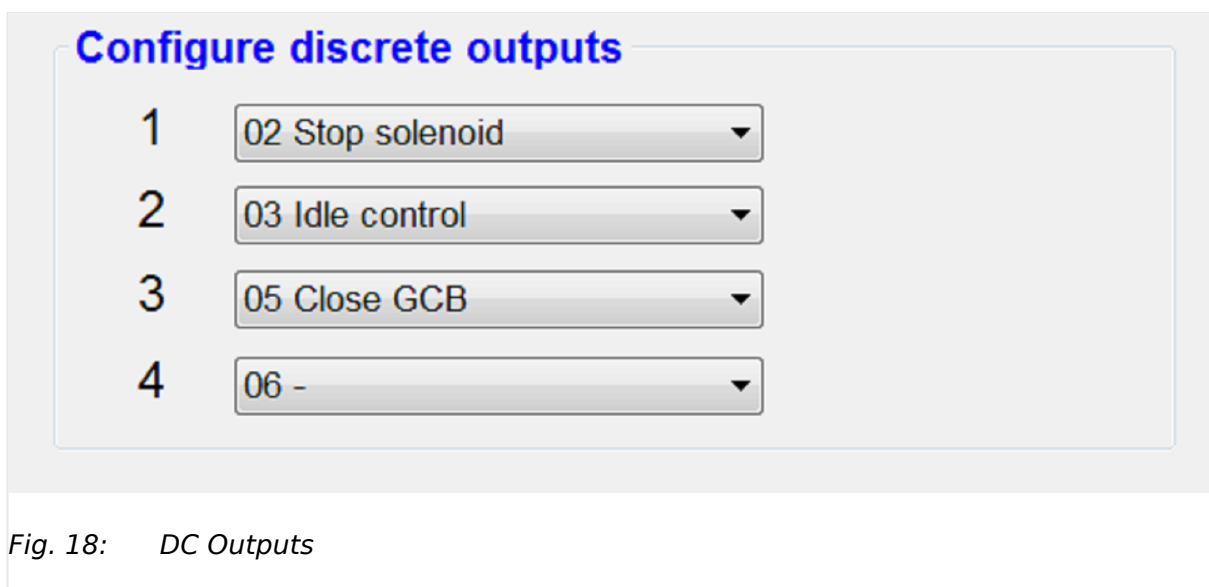

Fig. 18: DC Outputs

[PARAMETER / Configure application / Configure discrete outputs]

Items	Parameters	Defaults	Description
Configure discrete outputs			Notes For discrete outputs 1 to 4:
(Map Programmable Output)	00 to 26	02 Stop solenoid	Default of discrete output 1
		03 Idle control	Default of discrete output 2
		05 Close GCB	Default of discrete output 3
		06 -	Default of discrete output 4
			Notes See chapter ↪ "4.3.3 Programmable Outputs" for details



4.2.4.1.3 Configure Analog Inputs



[PARAMETER / Configure application / Configure inputs/outputs / Configure analog inputs / ...]

Items	Parameters	Defaults	Description
Temperature			
Type	00 to 14	08 SGX	See chapter ↪ "4.3.1 Programmable Sensors"



4 Configuration

4.2.4.1.3 Configure Analog Inputs

Items	Parameters	Defaults	Description
If a type (01 or higher) with curve is selected:	Curve can be loaded ... 	-/-	Notes For temperature curve management and customization.
	... and/or edited 	(curve)	
Wire break alarm	Warn Shutdown None	Warn	Alarm type to be released if wire break is detected
High limit shutdown	Immediate Stop Cooling Down	Immediate Stop	Reaction from the device if the high temperature alarm is triggered. Immediate Stop: The GCB opens and the engine stops immediately Cooling down: The GCB opens and the engine stops after the configured cooldown time.
Limit	80 to 140 °C	98 °C (208 °F)	Release the alarm when sensor value is same or higher than this value.
High temperature stop inhibit	Enabled / disabled	Disabled	The high temperature alarm can be disabled in order to keep the engine in operation. In this case, the high temperature is only a warning alarm.
Engine heater control	Enabled / disabled	Disabled	Notes »enabled«: The following related settings will be taken into account
On	0 to 300 °C	50 °C (122 °F)	The engine heater control is switched on if the actual temperature is lower than the configured threshold.
Off	0 to 300 °C	55 °C (131 °F)	The engine heater control is switched off if the actual temperature is higher than the configured threshold.
Delay	0 to 3600 min	60 min	Maximum activation time from the engine heater control. With a value of 0 the max. runtime is disabled.

Items	Parameters	Defaults	Description
Pressure			
Type	00 to 14	08 SGX	See chapter ↳ “4.3.1 Programmable Sensors”
If a type (01 or higher) with curve is selected:	Curve can be loaded ... 	-/-	Notes For pressure curve management and customization.
	... and/or edited 	(curve)	
Wire break alarm	Warn Shutdown None	Warn	Alarm type to be released if wire break is detected
Low limit shutdown	0 to 400 kPa	103 kPa (14.94 psi, 1.03 bar)	Release the alarm when sensor value is same or lower than this value and Delay time is over

Items	Parameters	Defaults	Description
Low oil pressure stop inhibit	Enabled / disabled	disabled	The low limit warning alarm does not stop the engine.

Items	Parameters	Defaults	Description
Fuel level			
Type	00 to 07	03 SGD	See chapter 4.3.1 Programmable Sensors
If a type (01 or higher) with curve is selected:	Curve can be loaded ... 	-/-	Notes For fuel level curve management and customization.
	... and/or edited 	(curve)	
Low limit warning	0 to 100 %	10 %	Warning alarm will be activated when sensor value is lower than the threshold.
Low limit shutdown	0 to 100 %	5 %	Shut down when sensor value is lower than the threshold.
Fuel pump control			
On	0 to 100 %	25 %	Release the alarm when sensor value is same or lower than this value and Delay time is over
Off	0 to 100 %	80 %	Cancel the alarm when sensor value is same or higher than this value and Delay time is over
Fuel tank capacity enable	Enabled / disabled	Disabled	Disabled: Fuel tank capacity is displayed in %. Enable: Additional visualization of fuel tank capacity in litres (L)
Fuel tank capacity	0 to 10000 L	1000 L	Select the respective fuel tank capacity in litres (L).

Items	Parameters	Defaults	Description
Displayed units			
Temperature	°C	°C	Select local temperature unit for display
	°F		
Pressure	kPa	kPa	Select local pressure unit for display
	psi		
	bar		

4.2.4.1.4 Configure external LEDs 1

[Parameter / Configure application / Configure external outputs / Configure ext. 1 discrete LEDs]

4 Configuration

4.2.4.1.4 Configure external LEDs 1

Ext. LED enable

Communication failure action Warning Label print

Mute button TX enable

1	Output(NO)	13 Operation mode AUTO	Green	Light
2	Output(NO)	04 Preglow	Green	Light
3	Output(NO)	17 Fuel	Green	Light
4	Output(NO)	18 Starter	Green	Light
5	Output(NO)	03 Idle control	Green	Light
6	Output(NO)	10 Generator running	Green	Light
7	Output(NO)	12 In operation	Green	Light
8	Output(NO)	03 Idle control	Green	Light
9	Output(NO)	02 Stop solenoid	Green	Light
10	Output(NO)	05 Close GCB	Yellow	Light
11	Output(NO)	07 Open GCB	Yellow	Light
12	Output(NO)	06 Close MCB	Yellow	Light
13	Output(NO)	26 Open MCB	Yellow	Light
14	Output(NO)	01 Centralized alarm	Red	Flash slow
15	Output(NO)	14 Stopping alarm	Red	Flash fast
16	Output(NO)	15 Horn	Red	Flash fast

Fig. 19: ToolKit-SC: Configure external LEDs

Items	Parameters	Defaults	Description
Ext. LED enable	enabled/disabled	disabled	<p>Notes</p> <p>All 16 external outputs are enabled/disabled together.</p> <p>»enabled«: The following related settings will be taken into account.</p>
Communication failure action	Not used Warning Shutdown	Warning	Alarm type to be released if wire break is detected.
Mute button TX enable	enabled/disabled	enabled	Allows the external LED signalling module to mute the horn signal.
(Adjust to logic)	Output (N.O.) Output (N.C.)	Output (N.O.)	Select according to logic of the connected signal (normally open or normally connected).
(Map Programmable Output)	00 to 299	00 Not Used	See chapter ↗ “4.3.3 Programmable Outputs” for details.

Label print

Once the configuration of external LEDs is complete, the corresponding LED labels can be printed on paper by means of the "Label print" button in . The following screen opens:

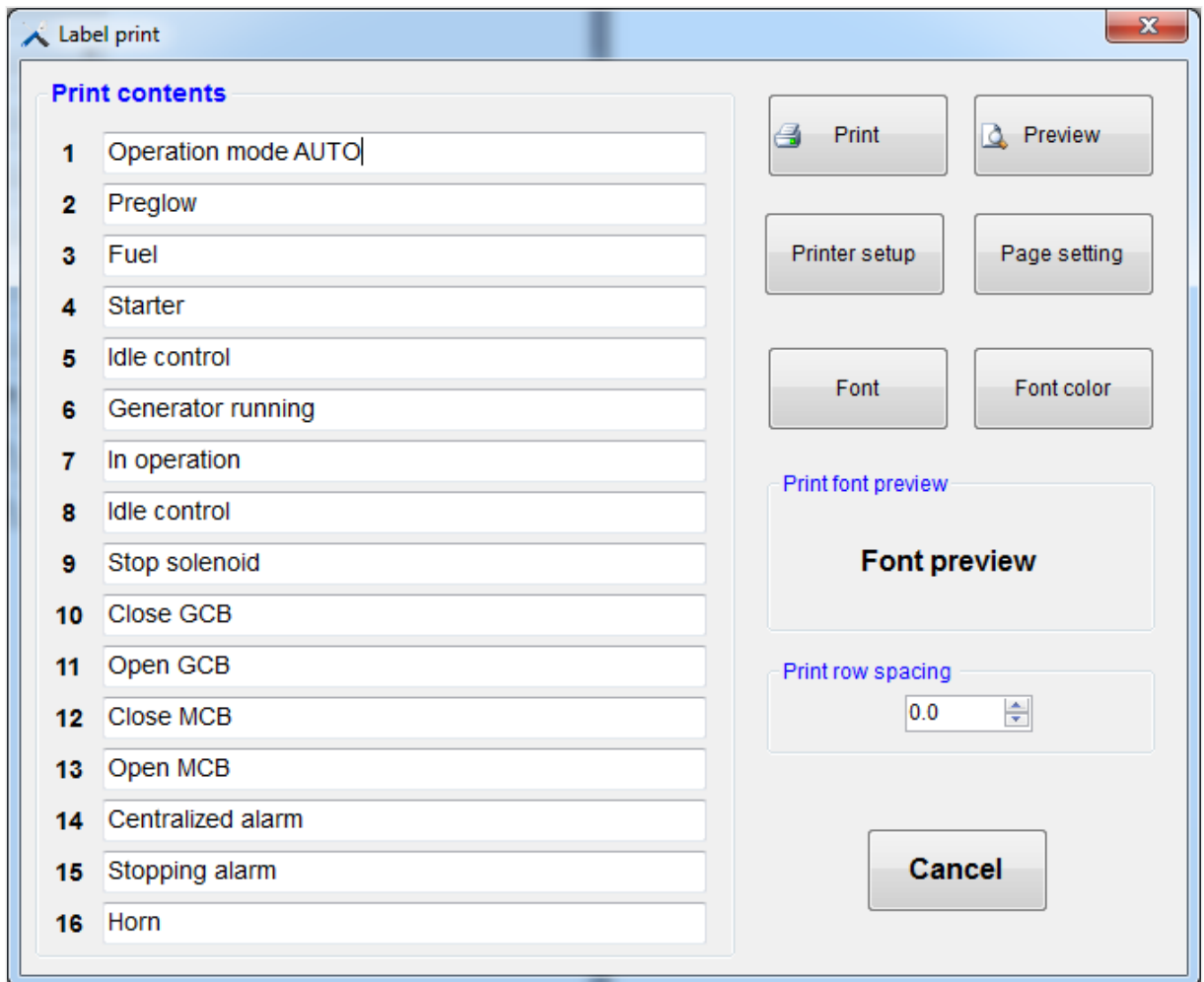

Fig. 20: Label print screen in Toolkit

In respective sixteen fields under "Print contents" the actual programmable output chosen in [Chapter 4.2.4.1.4](#) is displayed. The label font and its color can be selected as required by means of the "Font" and "Font color" buttons and previewed.

Further buttons allow to adjust the printout page parameters ("Page setting") and configure the printer ("Printer setup"). Finally, the actual appearance of labels can be controlled by pressing the "Preview" button.

To send the labels to the printer, the "Print" button needs to be pressed.

4.2.4.1.5 Configure external LEDs 2

[Parameter / Configure application / Configure external outputs / Configure ext. 2 discrete LEDs]

Here, the LED output for the second external module can be configured.

4 Configuration

4.2.4.2 Configure Engine

For description of the available options, settings and the parameter configuration, see [↳ “4.2.4.1.4 Configure external LEDs 1”](#).

4.2.4.2 Configure Engine

[PARAMETER / Configure application / Configure engine]

Items	Parameters	Defaults	Description
Engine options			
Engine Type	00 to 39	00 Con-venti-onal Engine	Default: Conventional genset (not J1939). When connected to J1939 engine, choose the corresponding type, see chapter ↳ “7.1 J1939” .
	00		Conventional engine
	01		General J1939
	02		Cummins ISB/ISBE
	03		Cummins QSL9 / CM850
	04		Cummins-QSK-Modbus
	05		Cummins QST-Modbus
	06		Cummins QSX-Modbus
	07		Cummins QSX15-CM570
	08		Cummins CM850-PCC13XX
	09		Cummins QSZ13
	10		Perkins
	11		Perkins 1100
	12		-
	13		-
	14		Volvo
	15		Volvo EMS2
	16		Volvo EMS2b
	17		Volvo EDC4
	18		-
	19		-
	20		Scania
21		Scania kw2000	

Items	Parameters	Defaults	Description
	22		Scania kw2k coo
	23		-
	24		-
	25		John Deere
	26		MTU ADEC (Smart Module) / ECU8
	27		MTU ADEC (SAM Module) / ECU7
	28		-
	29		-
	30		Deutz EMR2 / Volvo EDC4
	31		Woodward PG+
	32		BOSCH
	33		-
	34		GTSC1
	35		-
	36		YUCHAI / BOSCH
	37		MAN
	38		-
	39		-
MPU flywheel teeth	10 to 300	118	Tooth number of one 360° rotation, to determine crank disconnect conditions and inspect engine speed
ECU Inc. / Dec. steps	1 to 20 r/min	5 r/min	<p>The speed offset (J1939) works in combination with input sources (increase/decrease speed). The input sources can be configured to discrete inputs in order to adjust the speed of the engine. With an additional parameter the speed variation can be adjusted (Inc. / Dec. step 1 to 20 rpm) but the overall offset is limited to $\pm 10\%$ from rated speed.</p> <p>The speed offset is active as long as the engine is in operation and is automatically reset to zero if the engine stops.</p>
Speed on Load	0 to 100 %	90%	Setting value is percentage of rated speed. Controller detects when it is ready to load. It won't switch on when speed is under loading speed.
Configure Start/Stop			

4 Configuration

4.2.4.2 Configure Engine

Items	Parameters	Defaults	Description
Start Attempts	1 to 10 times	3	Max. number of crank attempts. When reaching this number, controller will send start failure signal.
Start timers			
Start delay	0 to 3600 s	1 s	Time from remote start signal is active to start genset
Fuel output time	1 to 60 s	1 s	Time delay between fuel relay activation and starter.
Preglow time	0 to 300 s	0 s	Time of pre-powering heat plug before starter is powered up
Starter time	3 to 60 s	8 s	Time of starter power up
Start pause time	3 to 60 s	10 s	The waiting time before second power up when engine start fails
Engine monitoring delay time	1 to 600 s	10 s	Alarms for low oil pressure, high temperature, under speed, under frequency /voltage, charge fail are inactive.
Start idle time	0 to 3600 s	0 s	Idle running time of genset when starting.
Warm up time	0 to 3600 s	10 s	Warming time between genset switch on and normal running
Stop timers			
Stop delay	0 to 3600 s	1 s	Time from remote start signal is active to start genset
Cool down time	0 to 3600 s	10 s	Radiating time before genset stop after unloading
Stop idle time	0 to 3600 s	0 s	Idle running time when genset stops
Stop solenoid hold	0 to 120 s	20 s	The time of powering up the electromagnet during stop procedure
Stop time of engine	0 to 120 s	0 s	A time accepted for a regular stop to standby. Activated once the "fail to stop delay" time (e.g. crank disconnect conditions contain oil pressure, and oil pressure drops quite slowly if genset stops) is reached.
Pulse time			
Speed raise pulse	0 to 20 s	0.2 s	The "speed raise pulse time" relates to the output "24 Speed raise pulse" and is active for the configured time after the starting sequence "start idle".
Speed drop pulse	0 to 20 s	0.2 s	The speed drop pulse time relates to the output "25 Speed lower pulse" and is active for the configured time after the stop sequence "stop idle".
Crank disconnect			

Items	Parameters	Defaults	Description
Firing speed RPM	enabled / disabled	enabled	
	0 to 3000 r/min	360 r/min	When the generator speed is higher than the set value, the starter will be disconnected. See the installation instructions.
Firing speed Hz	enabled / disabled	enabled	
	0.0 to 30 Hz	14.0 Hz	When generator frequency higher than the set value, starter will be disconnected. See the installation instructions.
Oil Pressure	enabled / disabled	disabled	
	0 to 400 kPa	200 kPa	When generator oil pressure higher than the set value, starter will be disconnected. See the installation instructions.
Disconnect OP time	0 to 20 s	0 s	The starter will be disconnected if the oil pressure is higher than the set value for the configured time.

NOTICE!

Disable "Firing speed RPM" if MPU is not available.

4.2.4.3 Configure TEST Run

[PARAMETER / Configure application / Configure TEST run]

Items	Parameters	Defaults	Description
Scheduled run	enabled/disabled	disabled	Notes »enabled«: The following related settings will be taken into account
Run mode	Off load On load	Off load	
Schedule period	Monthly Weekly Daily Custom weekly	Monthly	Notes »Custom weekly«: A table with 16 x setting blocks displays, each with ... <ul style="list-style-type: none"> Start time (weekly) to select a week day Start time (hh:mm) Duration (m)

4 Configuration

4.2.4.4 Configure Breakers

Items	Parameters	Defaults	Description
			The TEST run is disabled if the duration is "0" minutes. Max. duration is 30000 minutes.
Time (Day)	1 to 31	1	»Monthly«: Select a week day
	Sunday, to Saturday	Sunday	»Weekly«: Select a week day
Time (hour)	0 to 24 h	0 (o'clock)	Define the start time (hour)
Time (minute)	0 to 59	0	Define the start time (minute)
Duration	0 to 30000 min	30 min	Select the duration for a scheduled run
Auto start inhibit	enabled/disabled	disabled	Notes »enabled«: The following related settings will be taken into account
Schedule period	Monthly	Monthly	
	Weekly		
	Daily		
Time (Day)	1 to 31	1	»Monthly«: Select a week day
	Sunday, to Saturday	Sunday	»Weekly«: Select a week day
Time (hour)	0 to 24 h	0 (o'clock)	Define the start time (hour)
Time (minute)	0 to 59	0	Define the start time (minute)
Duration	0 to 30000 min	30 min	Select the duration for a scheduled run

4.2.4.4 Configure Breakers

[PARAMETER / Configure application / Configure breakers]

Items	Parameters	Defaults	Description
Configure breakers			
Manual mode ATS	Key switch	Default: Key switch.	Handling of the breaker in MAN mode.
	Auto switch		Key switch: Opens/closes breaker with the buttons. Auto switch: The controller logic is used to open/close the breaker and the related buttons are disabled.
Closing time	0.0 to 10.0 s	5.0 s	Pulse width of generator switch ON.
			Notes This is the duration from the closing pulse for GCB as well. If the time is configured to "zero" the closing pulse acts as a steady pulse.
Opening time	0.0 to 60.0 s	3.0 s	Pulse width of generator switch OFF

Items	Parameters	Defaults	Description
			<p>Notes</p> <p>This is the duration from the opening pulse for GCB as well.</p>

4.2.5 Configure Monitoring

4.2.5.1 Monitoring Generator

Monitoring Voltage

[PARAMETER / Configure monitoring / Generator / Voltage]

Items	Parameters	Defaults	Description
Overvoltage			
Limit	30 to 60000 V	264 V	<p>Release the alarm when generator voltage is same or higher than this value for 20 seconds.</p> <p>Note:</p> <p>If Limit is set to 60000 V, overvoltage monitoring is disabled. Hysteresis is fixed to 10 V.</p>
Action	Not Used/ Warn/ Shutdown	Not Used	Alarm type to be released if limit is exceeded
Undervoltage			
Limit	30 to 60000 V	196 V	<p>Release the alarm when generator voltage is same or lower than this value for 20 seconds.</p> <p>Note:</p> <p>If Limit is set to 30 V, undervoltage monitoring is disabled. Hysteresis is fixed to 10 V.</p>
Action	Not Used/ Warn/ Shutdown	Not Used	Alarm type to be released if limit is same or below than the limit value
Voltage Imbalance	0 to 200 %	0%	Release the alarm when Ph-Ph or Ph-N generator voltage is same or higher than this Limit
Action	Not Used/ Warn/ Shutdown	Not Used	Alarm type to be released if limit is exceeded

Monitoring Frequency

[PARAMETER / Configure monitoring / Generator / Frequency]

Items	Parameters	Defaults	Description
Overfrequency			
Limit	0.0 to 75 Hz	57.0 Hz	Release the alarm when generator frequency is same or higher than this value for 2 seconds.
Action	Not Used/ Warn/ Shutdown	Not Used	Alarm type to be released if limit is same or higher than the limit value.
Underfrequency			

4 Configuration

4.2.5.1 Monitoring Generator

Items	Parameters	Defaults	Description
Limit	0.0 to 75 Hz	45.0 Hz	Release the alarm when generator frequency is same or lower than this value for 10 seconds.
Action	Not Used/ Warn/ Shutdown	Not Used	Alarm type to be released if limit is same or higher than the limit value.

Monitoring Generator Current Alarm

[PARAMETER / Configure monitoring / Generator / Generator current alarm]

Items	Parameters	Defaults	Description
Generator current alarm			
Limit	50 to 130 %	120 % (600 A)	Release the alarm when sensor value is same or higher than this value and Delay time is over
Type	Define Time IDMT (Inverse definite minimum time)	Define time	
If Type is »Define Time«: Delay	0 to 3600 s	30 s	The alarm status change must be valid for this period of time before it is released. Note: If delay time is set to Zero, alarm will be only a warning alarm instead of a shutdown alarm.
If Type is »IDMT ...«: Multiply	1 to 36	36	»Multiply« defines the grade of reaction on the ratio of generator current to overcurrent setting. A low value means fast reaction (short delay time); the greater the value the slower reaction because longer delay time.

Monitoring Power

[PARAMETER / Configure monitoring / Generator / Power]

Items	Parameters	Defaults	Description
Overload	enabled/disabled	disabled	Notes »enabled«: The following related settings will be taken into account
Action	Not used Warn Shutdown	Not used	Alarm type to be released if wire break is detected. There is no wire breaker for this protection.
Limit	0 to 6000 kW	304 kW	Release the alarm when sensor value is same or higher than this value and Delay time is over
Return	0 to 6000 kW	290 kW	Reset the alarm when the active power is lower than this value
Delay	0 to 3600 s	5 s	The alarm status change must be valid for this period of time before it is released

4.2.5.2 Monitoring Breakers**Monitoring Breakers**

[PARAMETER / Configure monitoring / Breakers]

Items	Parameters	Defaults	Description
Enable breaker feedback monitoring	Enabled/disabled	Disabled	When breaker feedback monitoring is enabled, the device uses the configured discrete inputs for the breaker status.
Check fail warn(ing)	Enabled/disabled	Disabled	Enable the breaker feedback monitoring. This requires the "Enable breaker feedback monitoring".
Check time	0.0 to 20.0 s	5.0 s	Breaker monitoring delay time. After the configured check time, a breaker failure alarm is activated.

4.2.5.3 Monitoring Engine**Monitoring Speed**

[PARAMETER / Configure monitoring / Engine / Speed]

Items	Parameters	Defaults	Description
Overspeed shutdown			
Limit	0 to 6000 r/min	1710 r/min	Release the alarm when the MPU speed is same or higher than this value for 2 seconds.
Action	Not Used/ Warn/ Shutdown	Not Used	Alarm type to be released if limit is same or higher than the limit value.
Underspeed shutdown			
Limit	0 to 6000 r/min	1200 r/min	Release the alarm when the MPU speed is same or lower than this value for 10 seconds.
Action	Not Used/ Warn/ Shutdown	Not Used	Alarm type to be released if limit is same or higher than the limit value.
Loss of speed signal			
Delay	0 to 20 s	5 s	Release the alarm when the speed signal (MPU) is not available for this period of time.

4.2.5.4 Other Monitoring**Monitoring Battery Voltage**

[PARAMETER / Configure monitoring / Engine / Other monitoring / Battery voltage]

Items	Parameters	Defaults	Description
Overvoltage			
Limit	12.0 to 40.0 V	33.0 V	Release the alarm when sensor value is same or higher than this value
Action	Not Used/ Warn/ Shutdown	Not Used	Alarm type to be released if limit is same or higher than the limit value.
Undervoltage			

4 Configuration

4.2.6 Configure Interfaces

Items	Parameters	Defaults	Description
Limit	4.0 to 30.0 V	8.0 V	Release the alarm when sensor value is same or lower than this value
Action	Not Used/ Warn/ Shutdown	Not Used	Alarm type to be released if limit is same or higher than the limit value.

Monitoring Charge Alternator (D+)

[PARAMETER / Configure monitoring / Engine / Other monitoring / Charge alternator]

Items	Parameters	Defaults	Description
Charge alternator (D+)			
Charge alternator fail	0.0 to 30.0 V	6.0 V	The allowed maximum difference between the power supply and D+ voltages. Release the alarm when the voltage difference exceeds the set value.
Action	Not Used/ Warn/ Shutdown	Not Used	Alarm type to be released if limit is same or higher than the limit value.

4.2.6 Configure Interfaces

[PARAMETER / Configure interfaces]

Items	Parameters	Defaults	Description
Configure interface			
Baud rate	2400, 4800, 9600, 19200	19200	
Modbus slave ID	1 to 254	1	

4.2.7 Configure Maintenance

[PARAMETER / Configure maintenance]

Items	Parameters	Defaults	Description
Maintenance			
Password	0 to 9999	(0-9999)	Notes Customer-specific password for changing the maintenance intervall through the HMI.
Select Action	Not used Warn Shutdown	Not used	Defines the alarm class if the maintenance is triggered.

[PARAMETER / Configure maintenance interval to change]

Items	Parameters	Defaults	Description
Maintenance interval configured to change			
Interval	0 to 5000 h	250 h	Maintenance interval based on operation hours.
Time	Push icon	(current date)	Maintenance based on internal time.

[PARAMETER / Configure maintenance interval to reset]

Items	Parameters	Defaults	Description
Maintenance interval configured to reset			
Interval	0 to 5000 h	250 h	Maintenance interval based on operation hours.
Days	0 to 9999 d	365 d	Maintenance based on days.
Reset maintenance hours	Enable / Disable	Disable	Reset the maintenance due alarm for hours.
Reset maintenance days	Enable / Disable	Disable	Reset the maintenance due alarm for days.

4.2.8 Configure Counters

[PARAMETER / Configure counters]

Items	Parameters	Defaults	Description
Engine run			
Time	0 to 65534 hours	0 hours	Preset value
	0 to 59 min	0 min	Preset value
	Set (push button)		PUSH: Preset time is written to the connected easYgen
Start	0 to 65534	0	Preset value: Number of starts
	Set (push button)		PUSH: Preset number of starts is written to the connected easYgen
Current module	Display values of the device		Updated by pushing one of the set buttons above
Total run time			Total engine run time
Total start times			Total number of starts
Total energy			
kW	0 to 9999999.9 kW	0.0 kW	
	Set (push button)		PUSH: Preset kW value is written to the connected easYgen
Current module	Display values of the device		Displaying the values of the device
kW energy			Updated by pushing the set button (above)

4.2.9 Configure Language / Clock

[PARAMETER / Configure language / clock]

4 Configuration

4.2.10 Configure System Management

Items	Parameters	Defaults	Description
Language	English	English	One of the languages in the list may be selected for the HMI display.
	Chinese		
	Spanish		
	Russian		
	Portuguese		
	Turkish		
	Polish		
	French		
Date/Time			
Set value			
Date	Push icon	(current date)	Calendar sub module will be opened: DD.MM.YYYY
Time	Time display	(current time)	Time sub module enable comfortable setting time value: hh:mm:ss
Set	Push button		Write value to the easYgen device
Use PC time	Push button		Write PC time to the easYgen device
Current module	Date (YYYY-MM-DD)	(actual value)	Display device's value
	Time (hh:mm:ss)		



4.2.10 Configure System Management

[PARAMETER / Configure system management]

Items	Parameters	Defaults	Description
Configure system management			
Password	enabled/disabled	disabled	Enabled: <ul style="list-style-type: none"> Type in new password "eye symbol": switch between visible number and placeholder stars
	0 to 9999	0500	Factory setting for write access from ToolKit-Sc to the easYgen
Startup in mode	Stop mode	Stop mode	
	Manual mode		
	Auto mode		

4.2.11 Configure HMI

[PARAMETER / Configure HMI]

Items	Parameters	Defaults	Description
Activate start-up logo	Enabled/disabled	Disabled	Disabled: No logo is shown at startup
Start-up logo duration	0 to 3600 s	10 s	Duration of start-up logo time at device startup
Set start-up logo	Push button		Push: Opens sub menu to select a picture file (132 x 64 pixels black/white recommended) and upload it to the device
Select	Default theme OEM plant theme Terminal users theme		Select pre-defined theme or user-defined HMI theme. Theme configuration is disabled in "Default theme" mode.
If "OEM plant theme" or "Terminal users theme" is selected:	Load theme from file  Save theme to file 		Customize up to 12 screens by selecting options from the menu on the right and re-order them with drag and drop. Drag the options up or down to set the desired order. Remove an option by hitting the respective close button or dropping a different option on it. Once you have created a theme, save it to file by hitting the save button. Load a theme from file by hitting the load button.
Default reset	Push button		Reset theme to default settings
Activate start-up logo	Enabled/disabled	Enabled	Show customer's logo during start-up?

4.3 Selectable Inputs/Outputs/Sensors

4.3.1 Programmable Sensors

Selection

Sensor	Description	Remark
Temperature Sensor	0 Not used 1 User configured (Resistance) 2 VDO 3 SGH 4 SGD 5 CURTIS 6 DATCON 7 VOLVO-EC 8 SGX 9 to 10 Reserved 11 DIGITAL CLOSED	Defined resistance range is (0 to 6) KΩ. Default is »0 Not used«.

4 Configuration

4.3.1 Programmable Sensors

Sensor	Description	Remark
	12 DIGITAL OPEN 13 to 14 Reserved	
Pressure Sensor	0 Not used 1 Custom Res Curve 2 VDO 3 SGH 4 SGD 5 CURTIS 6 DATCON 7 VOLVO-EC 8 SGX 9 to 10 Reserved 11 CLOSED 12 OPEN 13 VDO 5 bar 14 Reserved	Defined resistance range is (0 to 6) KΩ. Default is »0 Not used«.
Fuel Level Sensor	0 Not used 1 User configured (Resistance) 2 SGH 3 SGD 4 to 5 Reserved 6 DIGITAL CLOSED 7 DIGITAL OPEN	Defined range of resistance is (0 to 6) KΩ. Default is »0 Not used«.

**Configuration/Setting**

When reselecting sensors, the sensor curve will be transferred to the standard value. For example, if a temperature sensor is SGX (120°C resistor type), its sensor curve is SGX (120°C resistor type); if you select the SGD (120°C resistor type), the temperature sensor curve is SGD curve.

If there is a difference between standard sensor curve and used sensor, it can be adjusted in the “curve type” menu.

When entering the the sensor curve values, the X value (resistor) must be in sequence from small to large, otherwise, mistakes can occur.

If you select the option None under sensor type, the sensor curve does not work.

If the corresponding sensor has an alarm switch only, set this sensor to “None”. Otherwise, shutdown or warnings can occur.

4.3.2 Programmable Inputs

The programmable inputs are all active, if connected to ground (B-).

Each input needs an alarm type and a release condition definition:

No.	Items	Description
0	Not Used	
1	High temperture shutdown	If the signal is active after safety run on delay over, the genset will immediately activate a shutdown alarm.
2	Low oil pressure shutdown	
3	Warning alarm	Only warning, no shutdown.
4	Shutdown alarm	If the signal is active, genset will immediately alarm to shutdown.
5	Shutdown in cooldown	When a high temperature occurs while the engine running and the input is active, the controller will stop after high speed cooling; When the input is disabled, the controller will stop immediately.
6	GCB closed	Connect to auxiliary port of gen load breaker.
7	-	-
8	-	Reserved
9	-	Reserved
10	Start request in	In Auto mode, when the input is active, the genset can be started and with load after genset is OK; when the input is inactive, the genset will stop automatically.
11	Fuel level warning	Connected to sensor digital input. The controller sends a warning alarm signal when active.
12	Coolant level warning	
13	Fuel level shutdown	Connected to sensor digital input. The controller sends a shutdown alarm signal when active.
14	Coolant level shutdown	
15	-	-

4 Configuration

4.3.3 Programmable Outputs

No.	Items	Description
16	Remote control	All buttons on panel are inactive except the four menu buttons to the right of the display. Additionally, remote mode is displayed on the LCD. Remote mode can switch module mode and start/stop operation via panel buttons.
17	Charging failure	Connect to failed to charge output.
18	Lock keypad	All buttons in panel are inactive except
19	Alarm Mute	Can deactivate alarm output when input is active.
20	Idle mode	Under voltage/frequency/speed protection is inactive
21	Enable 60Hz	Set »System rated frequency« to default of 60 Hz (e.g. used for CANBUS engine)
22	Raise speed (ECU)	If ECU type is generic J1939: CAN request increases engine speed in corresponding speed steps
23	Lower speed (ECU)	If ECU type is generic J1939: CAN request decreases engine speed by corresponding speed steps
24	Emergency stop	If this signal is active genset will shutdown immediately and Emergency Stop will be displayed

4.3.3 Programmable Outputs

No.	Items	Description
0	Not Used	Output is disabled when this item is selected.
1	Centralized Alarm	Include all shutdown alarms and warning alarms. When a warning alarm occurs, the alarm will not self-lock automatically; When a shutdown alarm occurs, the alarm will self-lock until the alarm is reset.
2	Stop solenoid	Used for the genset with stop solenoid. Pick-up when idle speed is over while disconnect when ETS delay is over.
3	Idle Control	Used for the genset with idle speed. Pick-up when crank while disconnect when enter into warming up. Pick-up when stop idle while disconnect when genset stop completely.
4	Preglow	Close before started and disconnect before powered on
5	Close GCB	When close time is set to 0 s, it is continuous closing
6	Reserved	
7	Open GCB	When close time is set to 0, "open breaker" is disabled
8	Raise speed	Pick-up when enter into warming up time. Disconnect when raise speed auxiliary input active
9	Lower speed	Pick-up when enter into stop idle or ETS solenoid stop (shutdown alarm). Disconnect when droop speed auxiliary input active
10	Generator running	Output when genset is running normally, disconnect when rotating speed is lower than engine speed after fired
11	Fuel Pump Control	Pick-up when the fuel level lower than the open threshold or low fuel level warning is active; disconnect when the fuel level over the close threshold and the low fuel level warning input is disabled
12	In operation	Output when it enters into warming up time, and disconnect after cooling
13	Operation mode AUTO	The controller is in Auto Mode
14	Stopping alarm	Output when shutdown alarm occurs and open when alarm is reset.

No.	Items	Description
15	Horn	When shutdown alarm and warn alarm occur, horn output becomes active and is set for 300 s. During this time, when any panel key or "alarm mute" input becomes active, the alarm is removed.
16	Heater control	It is controlled by cooler of temperature sensor's limited threshold
17	Fuel	Action when genset is starting and disconnect when stop is completed
18	Starter	Genset output in start output status and open in other status
19	ECU Stop	Used for ECU engine and control its stop
20	ECU Power Supply	Used for ECU engine and control its power
21	ECU Warning Alarm	Indicate ECU sends a warning signal
22	ECU Shutdown Alarm	Indicate ECU sends a shutdown signal
23	ECU timeout alarm	Indicate controller does not communicate with ECU
24	Speed raise pulse	HIGH for the pre-set »rise speed pulse time« after genset enters into high-speed warming period and before stop idling
25	Speed lower pulse	HIGH for the pre-set »drop speed pulse time« after entering stop idling
26	Reserved	
27	Reserved	
28	Reserved	
29	Reserved	

4.4 Status Menu

General notes

Both HMI and ToolKit-SC offer status information.

4.4.1 HMI Status Screens

HMI displays the following status screens:

- Status (home)
- Generator
- Load
- Engine 1
- Engine 2
- Status
- Alarm
- home screen etc.

4.4.2 ToolKit-SC Status Screens

General notes

ToolKit-SC lets you access status information via the following screens:

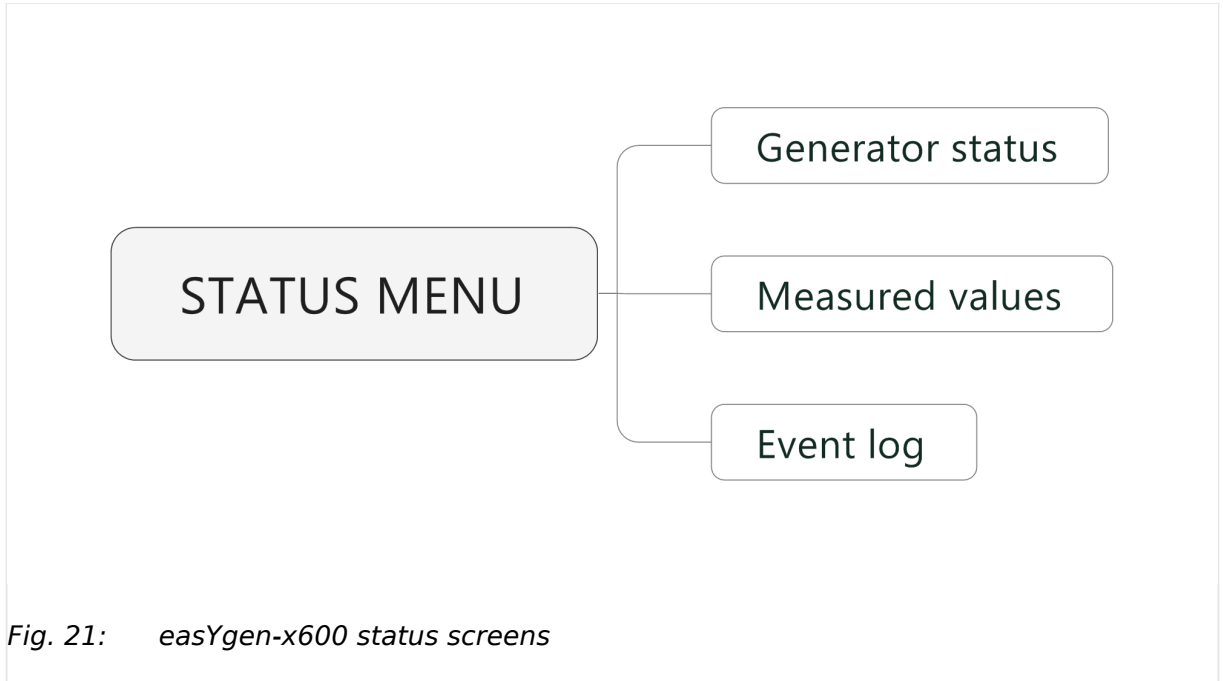

Fig. 21: easYgen-x600 status screens

Generator Status

[PARAMETER / STATUS MENU / Generator status]

Items	Parameters	Description
Engine info	Engine speed, Battery volt, Charger volt D+	
Sensor info	Engine temp, Oil pressure, Fuel level	Selection of ECU data via J1939.
More info	Coolant pressure, Coolant level, Fuel pressure, Fuel temp, Turbo pressure, Oil temp, Inlet temp, Fuel consume, Exhaust temp, Total consume	
Alarms	Current Alarms and Warning	Display of the lists of current alarms and warnings
(Digital)Inputs	01 High temperature shutdown, 02 Low oil pressure shutdown, 10 Start request in AUTO, 11 Fuel level warning, 12 Coolant level warning Emergency STOP	
(Digital) Outputs	02 Stop solenoid, 03 Idle control, 05 Close GCB, 06 - Fuel relay, Start relay	
Accumulation (run)	Time, Starts	

Items	Parameters	Description
Next maintenance time	Time	
Engine hours	Time	
Generator status	Gen status	
Module info	will be moved to Event log page	

Measured Values

[PARAMETER / STATUS MENU / Measured values]

Items	Parameters	Description
Electricity quantity		
Mains	-/-	
Generator	L1, L2, L3, L1-2, L2-3, L3-1, L1Phase, L2Phase, L3Phase, Frequency	
Current (A)	L1, L2, L3	
Active power (kW)	L1, L2, L3, Total	
Reactive power (kvar)	L1, L2, L3, Total	
Apparent power (kVA)	L1, L2, L3, Total	
Power factor	L1, L2, L3, Avg	

Ext. Analog Inputs

[PARAMETER / STATUS MENU / Ext. analog inputs]

Items	Parameters	Description
Expansion AIN24 {X}		{X}: 1 or 2
Cylinder Temp {Y}	(in °C and °F)	{Y}: 1 or 22
Exhaust Temp {Z}	(in °C and °F)	{Z}: 1 or 2
Sensor {N}		{N}: 15 or 24

Event Log and Version

[PARAMETER / STATUS MENU / Event log and version]

Items	Parameters	Description
Module Info	Model, Hardware Version, Software Version, Issue Date	
Event log	<p>Fixed view of:</p> <p>No., Event type</p> <p>Columns "move behind" visible part of the screen:</p> <p>Event Item, Date, Time,</p> <p>((Mains control is not supported by this model, so all "Mains" values are"0":)) <i>Mains Uab (V) / Ubc (V) / Uca (V), Mains Ua (V), Mains Ub (V), Mains Uc (V), Mains f (Hz),</i></p>	Event log report table. Shows the 99 latest events or - with SD card - the content of the .DAT file(s)

4 Configuration

4.4.2 ToolKit-SC Status Screens

Items	Parameters	Description
	Gens Uab (V) ..., Gens Ua (V) ..., Gens f(Hz), Current Ia (A) ..., Power (kW), Speed (r/min), Temp. (°C), Press. (kPa), Volt. (V)	
	Read log Clear Export to Txt	Push buttons to manage logged data (internal or SD card)

5 Operation

- Front Panel: Operating and Display Elements: See  "4.1.1 Front Panel: Operating and Display Elements"

5.1 Warning/Alarm Signaling

The Alarm type is visualized with an »Alarm« LED located beside the display.

Alarm Indicator LED	Alarm Type
Slow flashing	Warning
Fast flashing	Shutdown or Trip Alarm
ON (permanently illuminated)	Common Alarm, acknowledged

5.1.1 Alarm Acknowledgment

General notes

The alarm acknowledge handling is valid for following alarm classes

- Shutdown
- Trip/Stop
- Trip

Stop by alarm

The operation mode automatically changes to STOP if a stopping alarm is active (»Shutdown« or »Trip/Stop«).

Acknowledge alarm

The alarm can be reset by pressing the STOP button.

5.2 Operation Modes

General notes

The easYgen offers three operation modes:

- AUTO
- MANUAL (MAN)
- STOP
- ... and an internal (non) operating phase during the start of the device itself

The operation mode can be initiated – provided the current settings allow for this function:

5 Operation

5.2.1 Operation Mode AUTO

- directly by pressing the respective button on the front panel
- directly by click on the respective button on the ToolKit-SC remote screen
- via discrete inputs
- via interface

5.2.1 Operation Mode AUTO

General notes

In operation mode AUTO, both genset and breaker are under easYgen control. The start and stopping of the engine is managed automatically, along with opening/closing the breaker.

- supply load by generator
- start the engine
- stop the engine

5.2.2 Operation Mode MANual

General notes

In operation mode MANual, both genset and breakers are independent of each other under easYgen control.

The starting and stopping of the engine are managed using the same procedure as in AUTO mode but without breaker control. Breakers can be opened and closed without taking care of load or genset state!

CAUTION!



MANual breaker open/close request can destroy the genset.
Take care for genset and supply.

5.2.3 Operation Mode STOP

General notes

In operation mode STOP, the breaker is open and the engine is not running.



This is a configurable operation mode, only. This is NO emergency STOP!

5.3 START/STOP Operation

5.3.1 Start engine to supply load

The AUTO Start procedure is going through sub procedures with own timers.



The remaining time of each of the timers initiated is shown in the display.

When started via "Remote Start (off Load)" input, start procedures is the same as described below but breaker close relay is deactivated.

5 Operation

5.3.2 Stop engine

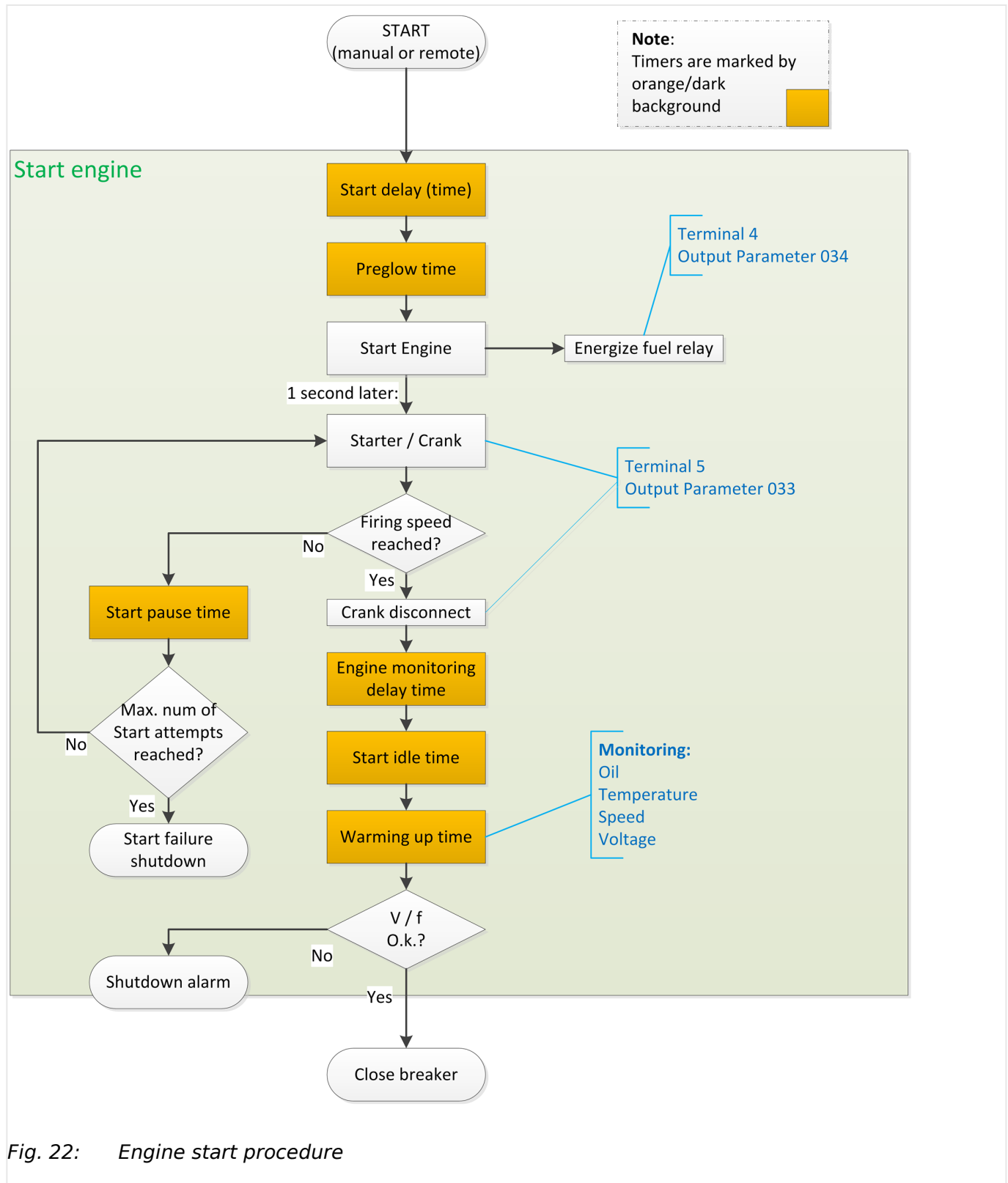

Fig. 22: Engine start procedure

5.3.2 Stop engine

The AUTO Stop procedure is going through sub procedures with own timers.



The remaining time of each of the timers initiated is shown in the display.

When started via “Remote Stop (off Load)” input, start procedures is the same as described below but breaker open relay is deactivated.

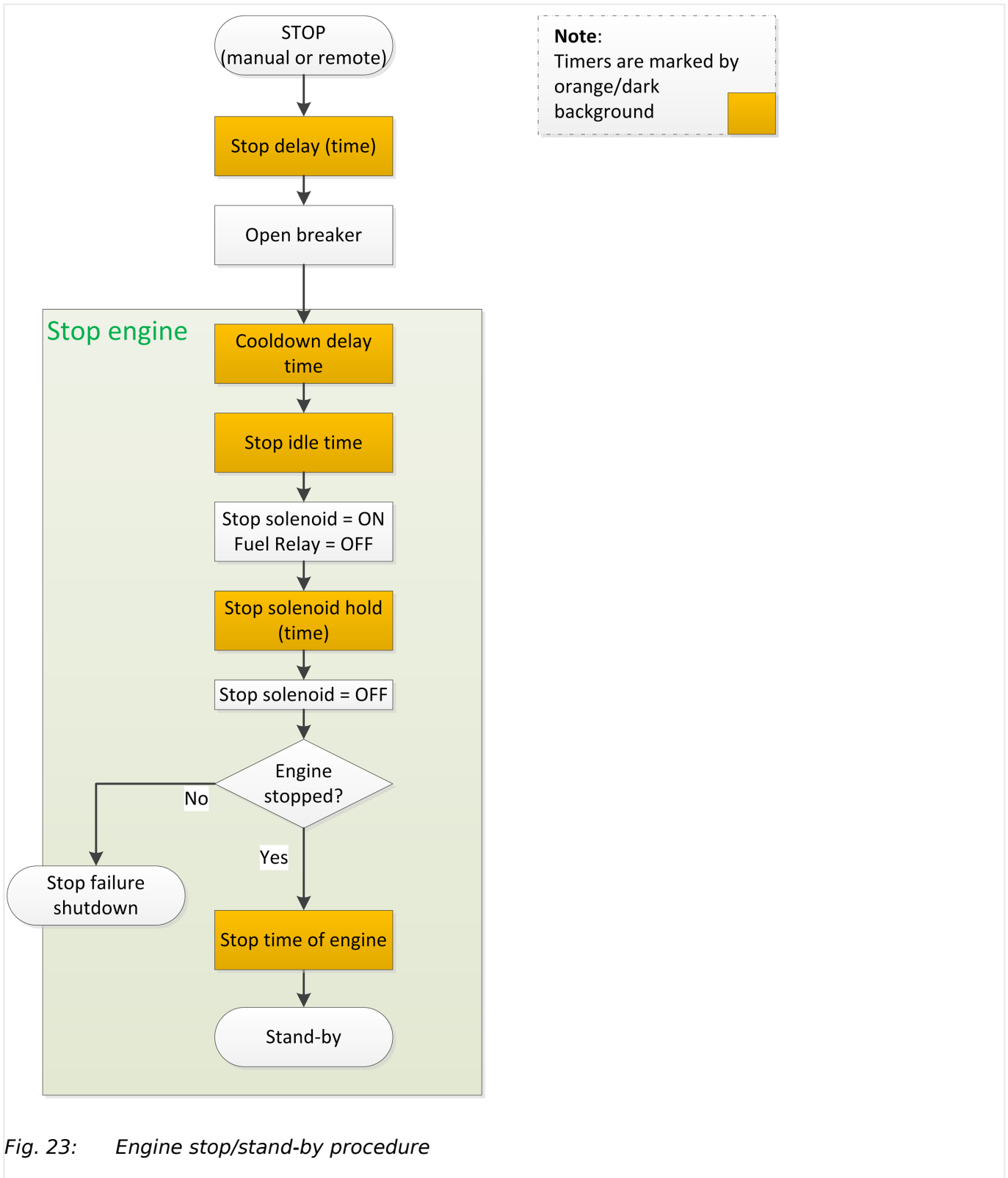

Fig. 23: Engine stop/stand-by procedure

5.3.3 MANual START/STOP



Engine control is separated from breaker management. Breaker(s) must be manually opened/closed (supply should be in normal range).



MANual Start

1. ▷

Press the MAN button



The LED next to the button will illuminate to confirm the operation

2. ▷

Press the START button  to start the genset as described above. In case of abnormal conditions, such as overheating, low oil pressure, over speed and abnormal voltage during generator running occur, the controller can protect genset by stopping quickly.



MANual Stop

1. ▷

Pressing  can stop the running generator as described above.

5.4 Transition Procedures

5.4.1 Disconnect during cranking

There are three conditions under control to abort the starting of the engine:

- speed sensor
- generator frequency
- engine oil pressure

They can be used separately or in combinations.

We recommend selecting all three at the same time: engine oil pressure together with speed sensor, and generator frequency. This allows for an immediate separation of the starter motor from the engine. Additionally, crank disconnect can be checked exactly.

When set to speed sensor, ensure that the number of flywheel teeth is the same as setting.



Sensor not used? Make sure not to select a sensor that is not in use. Otherwise, an error message might occur.



If the speed sensor (»Firing speed RPM«) is not selected, the rotating speed displayed on the controller is calculated from generator frequency and the number of poles.

If the generator frequency (»Firing speed Hz«) is not selected, the relative power quantity will neither be registered nor displayed (e.g. water pump application).



HMI only! In ToolKit-SC frequency, speed, and oil pressure can be enabled/disabled separately; HMI is using a table »Firing speed« instead:

No.	Setting description
0	Gen frequency
1	Speed sensor
2	Speed sensor + Gen frequency
3	Oil pressure
4	Oil pressure + Gen frequency
5	Oil pressure + Speed sensor
6	Oil pressure + Speed sensor + Gen frequency

6 Commissioning



Please go to the steps below, before starting normal operation

1. ▷ Ensure all the connections are correct and wires diameter is suitable
2. ▷ Ensure that the controller DC power has fuse, controller's positive and negative connected to start battery are correct
3. ▷ Emergence stop must be connected with positive of start battery via scram button's normal close point and fuse
4. ▷ Take proper action to prevent engine to crank disconnect (e. g. Remove the connection wire of fuel valve). If checking is OK, make the start battery power on; choose manual mode and controller will executive routine
5. ▷ Set controller under manual mode, press start button , genset will start. After the setting times as setting, controller will send signal of Start Fail; then press stop button  to reset controller
6. ▷ Recover the action of stop engine start (e. g. connect wire of fuel valve), press  again, genset will start. If everything goes well, genset will normal run after idle running (if idle run be set). During this time, please watch for engine's running situations and AC generator's voltage and frequency. If abnormal, stop genset running and check all wires connection according to this manual
7. ▷ If there is any other question, please contact your local Woodward support

7 Interfaces and Protocols

7.1 J1939

Cummins ISB/ISBE

Terminals of controller	Connector B	Remark
Fuel relay output	39	
Start relay output	-	Connect with starter coil directly
Auxiliary output port 1	Expand 30A relay, battery voltage of 01, 07, 12, 13 is supplied by relay	ECU power Set Auxiliary output 1 as "ECU power"
Terminals of controller	9 pins connector	Remark
CAN GND	SAE J1939 shield	CAN communication shielding line(connect with ECU terminal only)
CAN(H)	SAE J1939 signal	Impedance 120 Ω connecting line is recommended.
CAN(L)	SAE J1939 return	Impedance 120 Ω connecting line is recommended.

Cummins QSL9 / CM850 engine control module

Terminals of controller	50 pins connector	Remark
Fuel relay output	39	
Start relay output	-	Connect to starter coil directly
Terminals of controller	9 pins connector	Remark
CAN GND	SAE J1939 shield-E	CAN communication shielding line(connect with ECU terminal only)
CAN(H)	SAE J1939 signal-C	Impedance 120 Ω connecting line is recommended.
CAN(L)	SAE J1939 return-D	Impedance 120 Ω connecting line is recommended.

Cummins QSM 11 (Import) / CM570 engine control module

Terminals of controller	C1 connector	Remark
Fuel relay output	5&8	Outside expand relay, when fuel output, making port 5 and port 8 of C1 be connected
Start relay output	-	Connect to starter coil directly
Terminals of controller	3 pins data link connector	Remark
CAN GND	C	CAN communication shielding line(connect with ECU terminal only)
CAN(H)	A	Impedance 120 Ω connecting line is recommended.
CAN(L)	B	Impedance 120 Ω connecting line is recommended.

Cummins QSX15-CM570

Terminals of controller	50 pins connector	Remark
Fuel relay output	38	Oil spout switch
Start relay output	-	Connect to starter coil directly
Terminals of controller	9 pins connector	Remark
CAN GND	SAE J1939 shield-E	CAN communication shielding line(connect with ECU terminal only)
CAN(H)	SAE J1939 signal-C	Impedance 120 Ω connecting line is recommended.
CAN(L)	SAE J1939 return-D	Impedance 120 Ω connecting line is recommended.

Cummins GCS-Modbus / QSX15, QST30, QSK23-45-60-78-... via RS-485 Modbus

Terminals of controller	D-SUB connector 06	Remark
Fuel relay output	5&8	Outside expand relay, when fuel output, making port 05 and 08 of the connector 06 be connected.
Start relay output	-	Connect to starter coil directly
Terminals of controller	D-SUB connector 06	Remark
RS485 GND	20	CAN communication shielding line(connect with ECU terminal only)
RS485+	21	Impedance 120 Ω connecting line is recommended.
RS485-	18	Impedance 120 Ω connecting line is recommended.

Cummins QSM11 / Common J1939

Terminals of controller	OEM connector of engine	Remark
Fuel relay output	38	
Start relay output	-	Connect with starter coil directly
CAN GND	-	CAN communication shielding line(connect with controller's this terminal only)
CAN(H)	46	Impedance 120 Ω connecting line is recommended.
CAN(L)	37	Impedance 120 Ω connecting line is recommended.

Cummins QSZ13 / Common J1939

Terminals of controller	OEM connector of engine	Remark
Fuel relay output	45	
Start relay output	-	Connect to starter coil directly
Auxiliary output 1	16&41	Setting to idle speed control; normally close output. Making 16 connect to 41 during high-speed running of controller via external expansion relay.
Auxiliary output 2	19&41	Setting to pulse raise speed control; normally open output. Making 19 connect with 41 for 0.1s during high-speed warming of controller via external expansion relay.
CAN GND	-	CAN communication shielding line(connect with controller's this terminal only)

Terminals of controller	OEM connector of engine	Remark
CAN(H)	1	Impedance 120 Ω connecting line is recommended.
CAN(L)	21	Impedance 120 Ω connecting line is recommended.

Detroit Diesel DDEC III-IV / Common J1939

Terminals of controller	CAN port of engine	Remark
Fuel relay output	Expand 30A relay; battery voltage of ECU is supplied by relay.	
Start relay output	-	Connect to starter coil directly
CAN GND	-	CAN communication shielding line(connect with controller's terminal only)
CAN(H)	CAN(H)	Impedance 120 Ω connecting line is recommended.
CAN(L)	CAN(L)	Impedance 120 Ω connecting line is recommended.

Deutz EMR2 / Volvo EDC4

Terminals of controller	F connector	Remark
Fuel relay output	Expand 30A relay; battery voltage of terminal 14 is supplied by relay. Fuse is 16A.	
Start relay output	-	Connect to starter coil directly
-	1	Connect to battery negative pole
CAN GND	-	CAN communication shielding line(connect with controller's terminal only)
CAN(H)	12	Impedance 120 Ω connecting line is recommended.
CAN(L)	13	Impedance 120 Ω connecting line is recommended.

John Deere

Terminals of controller	21 pins connector	Remark
Fuel relay output	G, J	
Start relay output	D	
CAN GND	-	CAN communication shielding line(connect with controller's terminal only)
CAN(H)	V	Impedance 120 Ω connecting line is recommended.
CAN(L)	U	Impedance 120 Ω connecting line is recommended.

MTU ADEC (Smart Module) / ECU8

Terminals of controller	ADEC (X1port)	Remark
Fuel relay output	X1 10	X1 Terminal 9 Connected to negative of battery
Start relay output	X1 34	X1 Terminal 33 Connected to negative of battery
Terminals of controller	SMART (X4 port)	Remark
CAN GND	X4 3	CAN communication shielding line(connect to controller's this terminal only)
CAN(H)	X4 1	Impedance 120 Ω connecting line is recommended.
CAN(L)	X4 2	Impedance 120 Ω connecting line is recommended.

MTU ADEC (SAM Module) / ECU7, common J1939

Terminals of controller	ADEC (X1port)	Remark
Fuel relay output	X1 43	X1 Terminal 28 Connected to negative of battery
Start relay output	X1 37	X1 Terminal 22 Connected to negative of battery
Terminals of controller	SAM (X23 port)	Remark
CAN GND	X23 3	CAN communication shielding line(connect with controller's this terminal only)
CAN(H)	X23 2	Impedance 120 Ω connecting line is recommended.
CAN(L)	X23 1	Impedance 120 Ω connecting line is recommended.

Scania / S6 with DC9, DC12, and DC16

Terminals of controller	B1 connector	Remark
Fuel relay output	3	
Start relay output	-	Connect to starter coil directly
CAN GND	-	CAN communication shielding line(connect with controller's terminal only)
CAN(H)	9	Impedance 120 Ω connecting line is recommended.
CAN(L)	10	Impedance 120 Ω connecting line is recommended.

Volvo EDC3 / TAD1240, TAD1241, TAD1242

When this engine type is selected, preheating time should be set to at least 3 seconds.

Terminals of controller	"Stand alone" connector	Remark
Fuel relay output	H	
Start relay output	E	
Auxiliary output 1	P	ECU power Set Auxiliary output 1 as "ECU power"

Terminals of controller	"Data bus" connector	Remark
CAN GND	-	CAN communication shielding line(connect with controller's terminal only)
CAN(H)	1	Impedance 120 Ω connecting line is recommended.
CAN(L)	2	Impedance 120 Ω connecting line is recommended.

Volvo EDC4 / TD520, TAD520 (optional), TD720, TAD720 (optional), TAD721, TAD722, and TAD732

Terminals of controller	Connector	Remark
Fuel relay output	Expand 30A relay; battery voltage of terminal 14 is supplied by relay. Fuse is 16A.	
Start relay output	-	Connect to starter coil directly
	1	Connected to negative of battery
CAN GND	-	CAN communication shielding line(connect with controller's terminal only)
CAN(H)	12	Impedance 120 Ω connecting line is recommended.
CAN(L)	13	Impedance 120 Ω connecting line is recommended.

Volvo EMS2 / TAD734, TAD940, TAD941, TAD1640, TAD1641, and TAD1642.



When this engine type is selected, preheating time should be set to at least 3 seconds.

Terminals of controller	Engine's CAN port	Remark
Auxiliary output 1	6	ECU stop Set Auxiliary output 1 as "ECU Stop"
Auxiliary output 2	5	ECU power Set Auxiliary output 2 as "ECU power"
	3	Negative power
	4	Positive power
CAN GND	-	CAN communication shielding line(connect with controller's terminal only)
CAN(H)	1(Hi)	Impedance 120 Ω connecting line is recommended.
CAN(L)	2(Lo)	Impedance 120 Ω connecting line is recommended.

Yuchai / BOSCH

Terminals of controller	Engine 42 pins port	Remark
Fuel relay output	1,40	Connect to engine ignition lock
Start relay output	-	Connect to starter coil directly

7 Interfaces and Protocols

7.1 J1939

Terminals of controller	Engine 42 pins port	Remark
CAN GND	-	CAN communication shielding line(connect with controller's this terminal only)
CAN(H)	1,35	Impedance 120 Ω connecting line is recommended.
CAN(L)	1,34	Impedance 120 Ω connecting line is recommended.
Battery	Engine 2 pins	Remark
Battery negative	1	Wire diameter 2.5mm ²
Battery positive	2	Wire diameter 2.5mm ²

Weichai / GTSC1 with BOSCH

Terminals of controller	Engine port	Remark
Fuel relay output	1,40	Connect to engine ignition lock
Start relay output	1,61	
CAN GND	-	CAN communication shielding line(connect to the controller at this end only)
CAN(H)	1,35	Impedance 120 Ω connecting line is recommended.
CAN(L)	1,34	Impedance 120 Ω connecting line is recommended.

8 Technical Specifications

Ambient

Items		Contents
Power Supply	Operating Voltage	8.0 V _{DC} to 35.0 V _{DC} , Continuous Power Supply. Reverse polarity protected
	Maximum supply voltage	Short Time 80 V (5-10 s) Long Time 50 V
	Minimum supply voltage	6.5 V
	Maximum operating current	(All relays closed, LCD bright) 370 mA (12 V); 180 mA (24 V)
	Maximum standby current	(All relays closed, LCD dim) 320 mA (12 V); 160 mA (24 V)
Power Consumption		<3 W (standby ≤ 2 W)
Battery voltage measurement Accuracy		1% (12 V/24 V)
Alternator Input Range	3-Phase 4-Wire	15 Vac – 173 Vac (ph-N) (according to UL6200)
	3-Phase 3-Wire	30 Vac – 620 Vac (ph-ph)
	3-Phase 3-Wire	30 Vac – 300 Vac (ph-ph) (according to UL6200)
	Single-Phase 2-Wire	15 Vac – 173 Vac (ph-N) (according to UL6200)
	2-Phase 3-Wire	15 Vac – 173 Vac (ph-N) (according to UL6200)
AC-Measurement	Voltage Accuracy (400/480 V % rated)	Phase-phase: 100 .. 624 V : 1%; 50 .. 100 V : 1.5% Phase-phase: 100 .. 300 V : 1%; 50 .. 100 V : 1.5% (according to UL6200) Phase-neutral: 100 .. 173 V : 1% 50 .. 100 V : 1.5% (according to UL6200)
	Minimum frequency	Generator: 10 Hz

Items		Contents
	Maximum frequency	Generator: 99.5 Hz
	Frequency resolution	0.1 Hz (10 .. 99 Hz)
	Frequency accuracy	±0.1 Hz
	Nominal CT secondary rating	5 A
	Overload Measurement	Max.: 10 A
	Current Accuracy	1%
	Harmonics	up to 10th
Alternator Frequency		50 Hz/60 Hz
Case Dimension		209 mm × 166 mm × 45 mm Note: These devices are suitable for flat surface mounting in a Type 1 enclosure (UL6200).
Panel Cutout		187.5 mm × 142.5 mm
Working Conditions		Temperature: (−25 to +70) °C; Humidity: max. 93 %, non-condensing
Storage Condition		Temperature: (−25 to +70) °C
Protection Level against water and dust		Front: IP65 by using mounting material delivered with device Back: IP20
Net Weight		0.56 kg

Inputs/Outputs

Items		Contents
Speed Sensor	Voltage	1.0V to 24.0 V (RMS)
	Frequency	10,000 Hz (max.)
Excitation current D+		110 mA (12 V) 230 mA (24 V)
Start Relay Output		Rated 10 Adc, 24 Vdc running stand alone, rated 5 Adc, 24 Vdc when running in parallel with the FUEL relay Rated 2 Adc 24V dc, inductive (according to UL 6200)

Items		Contents
Fuel Relay Output		Rated 10 Adc, 24 Vdc running stand alone, rated 5 Adc, 24 Vdc when running in parallel with the STARTER relay Rated 2 Adc 24 Vdc, inductive (according to UL 6200)
Auxiliary Relay Output (1)		7 Adc 24 Vdc, resistive GP (according to UL 6200)
Auxiliary Relay Output (2)		7 Aac 250 Vac voltage free output, resistive GP
Auxiliary Relay Output (3 .. 4)		10 Aac 250 Vac voltage free output, resistive GP
Analog Inputs 01...03		Resistive, 0 to 6 kΩ
Digital Inputs	Low level threshold	Approx. 1.3 V
	Maximum input voltage	60 V
	Minimum input voltage	0 V
	High level threshold	1.7 V
CAN port (isolated)	Baud rate	250 K
USB Port	Max. allowed cable length	1.5 m
RS485 Serial port (isolated)	Baud rate	19200
	Duplex	Half
	Max. allowed cable length	1000 m

Approvals

EMC test (CE)	Tested according to applicable EMC standards.
Listings	CE UL/cUL; FTPM/7; File E347132. EAC

Display

- 132 × 64 monochrome LCD with backlight, multilingual interface (including English, Chinese or other languages) which can be chosen at the site, making commissioning convenient for factory personnel

- LCD wear-resistance and scratch resistance due to hard screen acrylic;

Housing

- Silicon panel and pushbuttons for better operation in high-temperature environment;
- Waterproof security level IP55 due to rubber seal installed between the controller enclosure and panel fascia
- Metal fixing clips enable perfect in high temperature environment
- Modular design, self-extinguishing ABS plastic enclosure, pluggable connection terminals and embedded installation way; compact structure with easy mounting
- AWG rating see [↩️ Table 1](#)
- Recommended locked torque: 4 inch pounds / 0.5 Nm

Interfaces

- RS485 communication port enabling:
 - remote control
 - remote measuring
 - remote communication via ModBus protocol
- CANbus port and can communicate with J1939 genset:
 - Monitoring frequently-used data (such as water temperature, oil pressure, speed, fuel consumption and so on) of ECU
 - Control START, STOP, raising speed, and speed droop

Phase Configuration

- Suitable for 3-phase 4-wire, 3-phase 3-wire, single phase 2-wire, and 2-phase 3-wire systems with
 - voltage 120/240V and
 - frequency 50/60Hz

8.1 Measuring and Monitoring

- Measures and monitors
 - 3-phase voltage, current, power parameter, and frequency of
 - generator.

Generator

- Line voltage (U_{ab} , U_{bc} , and U_{ca})
- Phase voltage (U_a , U_b , and U_c)
- Phase sequence
- Frequency Hz

- For generator, controller has over and under voltage, over and under frequency, loss of phase, phase sequence wrong, over and reverse power, over current functions

Load

- Current IA, IB, IC
- Each phase and total active power kW
- Each phase and total reactive power kvar
- Each phase and total apparent power kVA
- Each phase and average power factor PF
- Accumulate total generator power kWh, kvarh, kVAh
- Earth current A

Miscellaneous

- 3 fixed analog sensors (temperature, oil pressure and fuel level)
- Precision measure and display parameters about Engine:
- Temp. (WT) °C/°F both be displayed
- Oil pressure (OP) kPa/psi/bar all be displayed
- Fuel level (FL) %(unit)
- Speed (SPD) r/min (unit)
- Battery Voltage (VB) V (unit)
- Charger Voltage (VD) V (unit)
- Hour count (HC) can accumulate to max. 65535 hours.
- Start times can accumulate to max. 65535 times

9 Appendix

9.1 Alarms and Warnings

9.1.1 Alarm Classes

Alarm class	Visible in the display	LED and horn	Open GCB	Shut-down engine	Engine blocked until acknowledge
Warn	X				
	This alarm does not interrupt the operation of the unit. An output of the centralized alarm occurs and the "Horn" command is issued. Alarm text + flashing LED + Relay centralized alarm (horn)				
Shutdown	X	X	Immediately	Immediately	X
	The GCB is opened and the engine is stopped. Alarm text + flashing LED + Relay centralized alarm (horn) + GCB open + Engine stop.				
Trip/shut	x	x	Immediately	Cool down time	X
	The GCB is opened immediately and the engine is stopped after cool down. Alarm text + flashing LED + Relay centralized alarm (horn) + GCB open + Cool down + Engine stop.				
Trip	X	X	X		
	The GCB is opened but does not interrupt the operation of the unit. Alarm text + flashing LED + Relay centralized alarm (horn) + GCB open.				
Indication	X				
	This alarm does not interrupt the operation of the unit. A message output without a centralized alarm occurs. Alarm text				

9.1.2 Warnings

No.	Items	Description
1	Loss Of Speed Signal	When the speed of genset is 0 and speed loss delay is 0, controller will send a warning alarm signal that will be displayed in LCD.
2	Genset Over Current	When the current of genset is higher than threshold and setting over current delay is 0, controller will send warning alarm signal and it will be displayed in LCD.
3	Fail To Stop	When genset cannot stop after the "stop delay" is over, controller will send warning alarm signal and it will be displayed in LCD.
4	Low Fuel Level	When the fuel level of genset is lower than threshold or low fuel level warning is active, controller will send warning alarm signal and it will be displayed in LCD.
5	Failed To Charge	When the voltage of genset charger is lower than threshold, controller will send warning alarm signal and it will be displayed in LCD.
6	Battery Under Voltage	When the battery voltage of genset is lower than threshold, controller will send warning alarm signal and it will be displayed in LCD.
7	Battery Over Voltage	When the battery voltage of genset is higher than threshold, controller will send warning alarm signal and it will be displayed in LCD.
8	Low Coolant Level	When low coolant level input is active, controller will send warning alarm signal and it will be displayed in LCD.
9	Temp. Sensor Open	When sensor hasn't connected to corresponding port, controller will send warning alarm signal and it will be displayed in LCD.

No.	Items	Description
10	Oil Pressure Sensor Open	When sensor hasn't connected to corresponding port, controller will send warning alarm signal and it will be displayed in LCD.
11	Maintenance Warn	When genset running time is longer than maintenance time of user setting, and the maintenance action is set as warning, controller send warning alarm signal and it will be displayed in LCD. When maintenance action type is set as "Not used", maintenance alarm reset.
12	High Temp.	When the water/cylinder temperature of genset is higher than threshold and Enabled High Temp. Stop Inhibited or Input High Temp. Stop Inhibited is active, controller will send warning alarm signal and it will be displayed in LCD.
13	Low Oil Pressure	When the oil pressure of genset is less than threshold and Enabled Low Oil Pressure Stop Inhibited or Input Low Oil Pressure Stop Inhibited is active, controller will send warning alarm signal and it will be displayed in LCD.
14	Input Warn	When external input is active, controller will send warning alarm signal and it will be displayed in LCD.
15	Failed To Charge	When Failed To Charge input is active, controller will send warning alarm signal and it will be displayed in LCD.
16	Over Power	If over power detection is enabled, when the controller detects that the over power value (power is positive) has exceeded the pre-set value and the action select "Warn", it will initiate a warning alarm.
17	ECU Warn	If an error message is received from ECU via J1939, it will initiate a warning alarm.

9.1.3 Shutdown Alarms

When controller detects shutdown alarm, it will send signal to open breaker and shuts down generator.

No.	Items	Description
1	Emergency Stop	When controller detects emergency stop signal, it will send a stop alarm signal and it will be displayed in LCD.
2	High Temp. Shutdown	When the temperature of water/cylinder is higher than set threshold, controller will send a stop alarm signal and it will be displayed in LCD.
3	Low Oil Pressure Shutdown	When oil pressure is lower than threshold, controller will send a stop alarm signal and it will be displayed in LCD.
4	Over Speed Shutdown	When genset speed is higher than set threshold, controller will send a stop alarm signal and it will be displayed in LCD.
5	Under Speed Shutdown	When genset speed is lower than set threshold, controller will send a stop alarm signal and it will be displayed in LCD.
6	Loss Of Speed Signal Shutdown	When rotate speed is 0 and delay is not 0, controller will send a stop alarm signal and it will be displayed in LCD.
7	Genset Over Voltage Shutdown	When genset voltage is higher than threshold, controller will send a stop alarm signal and it will be displayed in LCD.
8	Genset Under Voltage Shutdown	When genset voltage is under set threshold, controller will send a stop alarm signal and it will be displayed in LCD.
9	Genset Over Current Shutdown	When genset current is higher than set threshold and delay is not 0, it will send a stop alarm signal and it will be displayed in LCD.
10	Failed To Start	Within set start times, if failed to start, controller will send a stop alarm signal and it will be displayed in LCD.
11	Over Freq. Shutdown	When genset frequency is higher than set threshold, controller will send a stop alarm signal and it will be displayed in LCD.

9 Appendix

9.2 Trouble Shooting

No.	Items	Description
12	Under Freq. Shutdown	When genset frequency is lower than set threshold, controller will send a stop alarm signal and it will be displayed in LCD.
13	Genset Failed	When genset frequency is 0, controller will send a stop alarm signal and it will be displayed in LCD.
14	Low Fuel Level	When fuel level low input is active, controller will send a stop alarm signal and it will be displayed in LCD.
15	Low Coolant Level	When genset coolant level low input is active, controller will send a stop alarm signal and it will be displayed on LCD.
16	Temp. Sensor Open	When sensor hasn't connected to corresponding port, controller will send shutdown alarm signal and it will be displayed in LCD.
17	Oil Sensor Open	When sensor hasn't connected to corresponding port, controller will send shutdown alarm signal and it will be displayed in LCD.
18	Maintenance shutdown	When genset running is longer than maintenance time of user setting, and maintenance action is set as shutdown, controller send shutdown alarm signal and it will be displayed in LCD. When maintenance action type is set as "Not used", maintenance alarm reset.
19	Input Shutdown	When external input is active, controller will send shutdown alarm signal and it will be displayed in LCD.
20	Over Power	If over power detection is enabled, when the controller detects that the over power value (power is positive) has exceeded the pre-set value and the action select "Shutdown", it will initiate a shutdown alarm.
21	ECU Shutdown	If an error message is received from ECU via J1939, it will initiate a shutdown alarm.
22	ECU Fail	If the module does not detect the ECU data, it will initiate a shutdown alarm.

9.2 Trouble Shooting

Symptoms	Possible Solutions
Controller has no power.	Check starting batteries; Check controller connection wiring; Check DC fuse.
Genset shutdown	Check if the water/cylinder temperature exceeds the limits; Check the genset AC voltage; Check DC fuse.
Controller emergency stop	Check if emergency stop button works properly; Check whether the starting battery's positive pole is connected to the emergency stop input; Check whether the circuit is open.
Low oil pressure alarm after crank disconnect	Check the oil pressure sensor and its connections.
High water temp. alarm after crank disconnect	Check the temperature sensor and its connections.
Shutdown Alarm in running	Check the switch and its connections according to the information on LCD; Check auxiliary input ports.
Fail to start	Check the fuel oil circuit and its connections; Check the starting batteries; Check the speed sensor and its connections; Refer to the engine manual.
Starter no response	Check the starter connections; Check the starting batteries.
Genset running while ATS not transfer	Check the ATS; Check the connections between ATS and controllers.
RS485 communication is abnormal	Check the connections; Check if the COM port setting is correct; Check RS-485 connections of A and B are reverse connected; Check if the RS485 transfer model is damaged; Check if the communication port of the computer is damaged.

Symptoms	Possible Solutions
ECU communication failed	Check the CAN connections for high and low polarity; Check if the 120 Ω resistor is connected properly; Check if the type of engine is correct; Check if the connections from the controller to the engine and the output ports settings are correct.
ECU warning or shutdown	Get information from the LCD of the alarm page; If there is a detailed alarm, check the respective engine. If there is no detailed alarm, please refer to the relevant section of the engine manual as specified in the SPN alarm code.

9.3 Data Telegrams

9.3.1 General Information

This chapter describes the Modbus communications protocol as supported by the easYgen x600 series automatic transfer system control Module.

It includes instructions on how to establish communication with the x600 Controller via the Serial Modbus RTU network.

Implementation Basics

The easYgen x600 supports the Modbus protocol on an RS-485 communication network, where it functions as a slave device. The RS-485 medium is a multi-drop standard, which allows for multiple slave devices on a single loop. The Modbus address and RS-485 baud rate are setup in the Network Settings of the easYgen x600.

Transmission Format

The easYgen x600 supports Modbus RTU format. Within the RTU mode, it uses the following serial port setting:

Start bit	1-bit
Data bit	8-bit
Parity bit	No parity
Stop bit	1 stop bit
Baud rate	9600bps

Modbus RTU Packet Format

Every Modbus Packet consists of the following fields:

- Device Address Field
- Function Code Field
- Data Field
- Error Check (CRC) Field

The maximum number of bytes contained within one packet of communications is 64.

Device Address Field. This is the first byte of each Modbus RTU transmission. The device address is a number limited to the range of 1 - 254 for the easYgen x600.

Function Code Field. This is a second byte of each transmission and represents the commanded action to the slave device (for queries from the master) or the action that was taken by the slave device (for responses from the slave). Codes between 1 and 127 are defined as Modbus RTU functions. Presently, 3 functions are supported:

1. Function #1. - Read Coils Status.
2. Function #3. - Read Holding Registers.
3. Function #5. - Force Single Coil.

Data Field. The Data Field varies in length depending on whether the message is a request or a response packet. This field typically contains information required by the slave device to perform the command specified in a request packet or data being passed back by the slave device in a response packet.

Error Check Field. The Error Check Field consists of a 16 bit Cyclical Redundancy Check (CRC16). It allows the receiving device to detect a packet that has been corrupted with transmission errors. Refer to CRC-16 Algorithm for details.

Packet Framing and Timing. The Modbus RTU protocol does not define any explicit packet synchronization bytes. Synchronization is accomplished implicitly with the use of silent intervals. According to the Modbus RTU standard, all master messages must start with a silent interval of at least 3.5 character times. This means that every byte within a packet must precede the next byte by fewer than 3.5 character times based on the baud rate. And every new packet of data must begin at least 3.5 character times or more after the packet that had preceded it.

CRC-16 Algorithm Procedure.

The algorithm essentially treats the entire data packet (less the start, stop, and, if used, parity bits) as one continuous binary number.

The CRC field is two bytes, containing a 16-bit binary value. The CRC value is calculated by the transmitting device, which appends the CRC to the message. The receiving device recalculates a CRC during receipt of the message, and compares the calculated value to the actual value it received in the CRC field. If the two values are not equal, an error will occur.

When the CRC is appended to the message, the low-order byte is appended first, followed by the high-order byte. The steps for generating the 16-bit CRC checksum are as follows:

1. Initially, load the 16-bit CRC register with the value FFFF hex.
2. Exclusive OR the 16-bit CRC register with the first data byte of the packet and store the result in the 16-bit CRC register.
3. If the Least Significant Bit (LSB) of the 16-bit CRC register is equal to one, then shift the 16-bit CRC register to the right by one bit and then Exclusive OR the result with the generator polynomial, A001hex. Otherwise, just shift the 16-bit CRC register to the right by one bit.
4. Repeat step 3 until eight right shifts have been performed.
5. Exclusive OR the 16-bit CRC register with the next data byte of the packet.
6. Repeat steps 3-5 until all the bytes of the data packet have been used in step 5.
7. The 16-bit CRC register contains the new checksum to be appended to the end of the packet, Least Significant Byte first.

CRC-16 Pseudocode: Below is the pseudocode for generating the 16-bit CRC checksum. XOR is the Exclusive-OR function:

CRC16REG = FFF hex

GENPOLY = A001 hex

FOR **X** = 1 to number of bytes in packet

BEGIN

XOR **CRC16REG** CRC16REG with the Xth data byte

FOR **Y** = 1 to 8

BEGIN

IF [(the least-significant-bit of CRC16REG) = 1] THEN

SHIFT **CRC16REG** one bit to the RIGHT

XOR **CRC16REG** with **GENPOLY**

OTHERWISE

SHIFT **CRC16REG** one bit to the RIGHT

END

NEXT **Y**

END

NEXT **X**

The resulting **CRC16REG** contains the 16-bit CRC checksum.

9.3.2 Supported Function Codes

9.3.2.1 Function # 01 (01h) - Read COIL STATUS

This function code allows the master to read one or more consecutive coils status from the easYgen x600. The query message specifies the starting coil and quantity of coils to be read. Coils are addressed starting at zero: coils 1-16 are addressed as 0-15.

Here is an example of a request to read coils 0-71 from slave device 1:

Field Name	Example (Hex)
Slave address	01
Function	01
Starting address Hi	00
Starting Address Lo	00
No. of Points Hi	00
No. of Points Lo	48

9 Appendix

9.3.2.2 Function # 03 (03h) - Read Holding Registers

Field Name	Example (Hex)
Error Check	-

Table 2: Master Transmission

The Query string is "01 01 00 00 00 48 3C 3C"

Field Name	Example (Hex)
Slave address	01
Function	01
Byte Count	09
Data (Coils 07-00)	58
Data (Coils 15-08)	00
Data (Coils 23-16)	00
Data (Coils 31-24)	00
Data (Coils 39-32)	00
Data (Coils 47-40)	00
Data (Coils 55-48)	00
Data (Coils 63-56)	00
Data (Coils 71-64)	00
Error Check	-

Table 3: easYgen x600 Controller Response

The Response string is "01 01 09 58 00 00 00 00 00 00 00 00 D6 D1".

The status of coils 07-00 is shown as the byte value 58 hex, or binary 0101 1000. Coil 07 is the MSB of this byte, and coil 00 is the LSB. Left to right, the status of coils 07 through 00 is: OFF- ON- OFF- ON- ON- OFF- OFF- OFF.

By convention, bits within a byte are shown with the MSB to the left, and the LSB to the right. Thus the coils in the first byte are „07 through 00“, from left to right.

The next byte has coils „15 through 08“, left to right. As the bits are transmitted serially, they flow from LSB to MSB: 00 . . . 07, 08 . . . 15, and so on.

9.3.2.2 Function # 03 (03h) - Read Holding Registers

This function code allows the master to read one or more consecutive data registers from the easYgen x600. The data registers are always 16 bit (two byte) values, transmitted high order byte first.

The following example shows the format of a transmission between a master client device and the responding easYgen x600 at address 1. The master desires to read the

Timestamp, beginning at Holding register location 0000 (which is a “Data starting address” of 00 decimal).

Field Name	Example (Hex)
Slave address	01
Function	03
Starting address Hi	00
Starting Address Lo	00
No. of Points Hi	00
No. of Points Lo	03
Error Check	-

Table 4: Master Transmission

The Query string is “01 03 00 00 00 03 05 CB”

Field Name	Example (Hex)
Slave address	01
Function	03
Byte Count	06
Data Hi (Register 0000)	00
Data Lo (Register 0000)	DB
Data Hi (Register 0002)	00
Data Lo (Register 0002)	DC
Data Hi (Register 0004)	00
Data Lo (Register 0004)	DD
Data Hi (Register 0000)	00
Error Check	-

Table 5: easYgen x600 Controller Response

The Response string is “01 03 06 00 DB 00 DC 00 DD 44 C5”.

The contents of register 0000 are shown as the two byte values of 00 DB hex, or 219 decimal. The contents of registers 0002 -0004 are 00 DC and 00 DD hex, or 220 and 221 decimal.

9.3.2.3 Function # 05 (05h) - Force Single Coil

This function code allows the master device to modify the contents of a single configuration coil within the easYgen x600.

9 Appendix

9.3.3 Function #1 Coil Status Map

The requested ON/OFF state is specified by a constant in the query data field. A value of 00 FF hex requests the coil to be ON. A value of 00 00 requests it to be OFF. All other values are illegal and will not affect the coil.

The following example shows the format of a transmission between a client device and the responding easYgen x600 at address 1. It request to force coil 00 ON in slave device 1:

Field Name	Example (Hex)
Slave address	01
Function	05
Starting address Hi	00
Starting Address Lo	00
No. of Points Hi	00
No. of Points Lo	FF
Error Check	-

Table 6: Master Transmission

The Query string is "01 05 00 00 00 FF 8C 3A"

The normal response is an echo of the query, returned after the coil state has been forced.

Field Name	Example (Hex)
Slave address	01
Function	05
Starting address Hi	00
Starting Address Lo	00
No. of Points Hi	00
No. of Points Lo	FF
Error Check	-

Table 7: easYgen x600 Controller Response

The Response string is "01 05 00 00 00 FF 8C 3A".

9.3.3 Function #1 Coil Status Map

Item	Address	Content
1	0000H	Common alarm
2	0001H	Common warn
3	0002H	Common shutdown

Item	Address	Content
4	0003H	Reserved
5	0004H	Reserved
6	0005H	Generators Normal
7	0006H	Mains Load
8	0007H	Generators Load
9	0008H	EM stop shutdown
10	0009H	Over speed shutdown
11	000AH	Under speed shutdown
12	000BH	Loss of speed shutdown
13	000CH	Over frequency shutdown
14	000DH	Under frequency shutdown
15	000EH	Over Gens voltage shutdown
16	000FH	Under Gens voltage shutdown
17	0010H	Over Current shutdown
18	0011H	Failed to start shutdown
19	0012H	High engine Temperature shutdown
20	0013H	Low oil pressure shutdown
21	0014H	Loss of frequency shutdown
22	0015H	Input shutdown
23	0016H	Reserved
24	0017H	Reserved
25	0018H	High engine Temperature warn
26	0019H	Low oil pressure warn
27	001AH	Over Current warn
28	0001BH	Failed to stop warn
29	001CH	Low fuel level warn
30	001DH	Charge fail warn
31	001EH	Under Battery voltage warn
32	001FH	Over Battery voltage warn
33	0020H	Input warn
34	0021H	Reserved
35	0022H	Reserved
36	0023H	Reserved
37	0024H	Reserved
38	0025H	Reserved
39	0026H	Reserved
40	0027H	Reserved
41	0028H	System At Test mode

9 Appendix

9.3.3 Function #1 Coil Status Map

Item	Address	Content
42	0029H	System At Auto mode
43	002AH	System At Manu mode
44	002BH	System At Stop mode
45	002CH	Reserved
46	002DH	Reserved
47	002EH	Reserved
48	002FH	Reserved
49	0030H	EM stop input closed
50	0031H	Input 1 closed
51	0032H	Input 2 closed
52	0033H	Input 3 closed
53	0034H	Input 4 closed
54	0035H	Input 5 closed
55	0036H	Reserved
56	0037H	Reserved
57	0038H	Start relay output
58	0039H	Fuel relay output
59	003AH	Config output1
60	003BH	Config output2
61	003CH	Config output3
62	003DH	Config output4
63	003EH	Reserved
64	003FH	Reserved
65	0040H	Mains abnormal
66	0041H	Mains normal
67	0042H	Mains Over voltage
68	0043H	Mains Under voltage
69	0044H	Mains Lost Phase
70	0045H	Reserved
71	0046H	Reserved
72	0047H	Reserved

Item	Address	Content
1	0000H	Common alarm
2	0001H	Common warn
3	0002H	Common shutdown
4	0003H	Reserved
5	0004H	Reserved

Item	Address	Content
6	0005H	Generators Normal
7	0006H	Mains Load
8	0007H	Generators Load
9	0008H	EM stop shutdown
10	0009H	Over speed shutdown
11	000AH	Under speed shutdown
12	000BH	Loss of speed shutdown
13	000CH	Over frequency shutdown
14	000DH	Under frequency shutdown
15	000EH	Over Gens voltage shutdown
16	000FH	Under Gens voltage shutdown
17	0010H	Over Current shutdown
18	0011H	Failed to start shutdown
19	0012H	High engine Temperature shutdown
20	0013H	Low oil pressure shutdown
21	0014H	Loss of frequency shutdown
22	0015H	Input shutdown
23	0016H	Reserved
24	0017H	Reserved
25	0018H	High engine Temperature warn
26	0019H	Low oil pressure warn
27	001AH	Over Current warn
28	0001BH	Failed to stop warn
29	001CH	Low fuel level warn
30	001DH	Charge fail warn
31	001EH	Under Battery voltage warn
32	001FH	Over Battery voltage warn
33	0020H	Input warn
34	0021H	Reserved
35	0022H	Reserved
36	0023H	Reserved
37	0024H	Reserved
38	0025H	Reserved
39	0026H	Reserved
40	0027H	Reserved
41	0028H	System At Test mode
42	0029H	System At Auto mode
43	002AH	System At Manu mode

9 Appendix

9.3.4 Function #3 Register Map

Item	Address	Content
44	002BH	System At Stop mode
45	002CH	Reserved
46	002DH	Reserved
47	002EH	Reserved
48	002FH	Reserved
49	0030H	EM stop input closed
50	0031H	Input 1 closed
51	0032H	Input 2 closed
52	0033H	Input 3 closed
53	0034H	Input 4 closed
54	0035H	Input 5 closed
55	0036H	Reserved
56	0037H	Reserved
57	0038H	Start relay output
58	0039H	Fuel relay output
59	003AH	Config output1
60	003BH	Config output2
61	003CH	Config output3
62	003DH	Config output4
63	003EH	Reserved
64	003FH	Reserved
65	0040H	Mains abnormal
66	0041H	Mains normal
67	0042H	Mains Over voltage
68	0043H	Mains Under voltage
69	0044H	Mains Lost Phase
70	0045H	Reserved
71	0046H	Reserved
72	0047H	Reserved

9.3.4 Function #3 Register Map

Item	Address	Content
1	0000H	Mains phase A voltage (Line- Nature) (unit: V)
2	0001H	Mains phase B voltage (Line- Nature) (unit: V)
3	0002H	Mains phase C voltage (Line- Nature) (unit: V)
4	0003H	Mains phase AB voltage (Line- Line) (unit: V)
5	0004H	Mains phase BC voltage (Line- Line) (unit: V)

Item	Address	Content
6	0005H	Mains phase CA voltage (Line- Line) (unit: V)
7	0006H	Mains frequency (unit: 0.1Hz)
8	0007H	Generator phase A voltage (Line- Nature) (unit: V)
9	0008H	Generator phase B voltage (Line- Nature) (unit: V)
10	0009H	Generator phase C voltage (Line- Nature) (unit: V)
11	000AH	Generator phase AB voltage (Line- Line) (unit: V)
12	000BH	Generator phase BC voltage (Line- Line) (unit: V)
13	000CH	Generator phase CA voltage (Line- Line) (unit: V)
14	000DH	Generator frequency (unit: 0.1Hz)
15	000EH	Phase A current (unit: 0.1A)
16	000FH	Phase B current (unit: 0.1A)
17	0010H	Phase C current (unit: 0.1A)
18	0011H	Temperature (unit: celsius degree)
19	0012H	Temperature sender resistor
20	0013H	pressure (unit: kPa)
21	0014H	pressure sender resistor
22	0015H	Level (unit: %)
23	0016H	Level sender resistor
24	0017H	Speed (unit: RPM)
25	0018H	Battery voltage (unit: 0.1V)
26	0019H	Charger D+ voltage (unit: 0.1V)
27	001AH	Total active power(unit: 0.1kW)
28	0001BH	Total Reactive power(unit: 0.1kVar)
29	001CH	Total Apparent power(unit: 0.1kVA)
30	001DH	power-factor(0.01)
31	001EH	Reserved
32	001FH	Reserved
33	0020H	Reserved
34	0021H	Reserved
35	0022H	Generator state
36	0023H	Generator delay
37	0024H	Remote start state
38	0025H	Remote start delay
39	0026H	ATS state
40	0027H	ATS delay
41	0028H	Mains state
42	0029H	Mains delay
43	002AH	Hours of run (high)(0-9999)

9 Appendix

9.3.4 Function #3 Register Map

Item	Address	Content
44	002BH	Hours of run (low) (0-9999)
45	002CH	Minutes of run (0-59)
46	002DH	Seconds of run (0-59)
47	002EH	Num of start(high)(0-9999)
48	002FH	Num of start(low)(0-9999)
49	0030H	Total Energy(high)(0-9999)
50	0031H	Total Energy(low)(0-9999)
51	0032H	Soft Version
52	0033H	Reserved

Item	Address	Content
1	0000H	Mains phase A voltage (Line- Nature) (unit: V)
2	0001H	Mains phase B voltage (Line- Nature) (unit: V)
3	0002H	Mains phase C voltage (Line- Nature) (unit: V)
4	0003H	Mains phase AB voltage (Line- Line) (unit: V)
5	0004H	Mains phase BC voltage (Line- Line) (unit: V)
6	0005H	Mains phase CA voltage (Line- Line) (unit: V)
7	0006H	Mains frequency (unit: 0.1Hz)
8	0007H	Generator phase A voltage (Line- Nature) (unit: V)
9	0008H	Generator phase B voltage (Line- Nature) (unit: V)
10	0009H	Generator phase C voltage (Line- Nature) (unit: V)
11	000AH	Generator phase AB voltage (Line- Line) (unit: V)
12	000BH	Generator phase BC voltage (Line- Line) (unit: V)
13	000CH	Generator phase CA voltage (Line- Line) (unit: V)
14	000DH	Generator frequency (unit: 0.1Hz)
15	000EH	Phase A current (unit: 0.1A)
16	000FH	Phase B current (unit: 0.1A)
17	0010H	Phase C current (unit: 0.1A)
18	0011H	Temperature (unit: celsius degree)
19	0012H	Temperature sender resistor
20	0013H	pressure (unit: kPa)
21	0014H	pressure sender resistor
22	0015H	Level (unit: %)
23	0016H	Level sender resistor
24	0017H	Speed (unit: RPM)
25	0018H	Battery voltage (unit: 0.1V)
26	0019H	Charger D+ voltage (unit: 0.1V)
27	001AH	Total active power(unit: 0.1kW)

Item	Address	Content
28	0001BH	Total Reactive power(unit: 0.1kVar)
29	001CH	Total Apparent power(unit: 0.1kVA)
30	001DH	power-factor(0.01)
31	001EH	Reserved
32	001FH	Reserved
33	0020H	Reserved
34	0021H	Reserved
35	0022H	Generator state
36	0023H	Generator delay
37	0024H	Remote start state
38	0025H	Remote start delay
39	0026H	ATS state
40	0027H	ATS delay
41	0028H	Mains state
42	0029H	Mains delay
43	002AH	Hours of run (high)(0-9999)
44	002BH	Hours of run (low) (0-9999)
45	002CH	Minutes of run (0-59)
46	002DH	Seconds of run (0-59)
47	002EH	Num of start(high)(0-9999)
48	002FH	Num of start(low)(0-9999)
49	0030H	Total Energy(high)(0-9999)
50	0031H	Total Energy(low)(0-9999)
51	0032H	Soft Version
52	0033H	Reserved

9.3.5 Function #5 Remote coils Map

Item	Address	Content	
1	0000H	Start generator	Active when set to 1
2	0001H	Stop generator	Active when set to 1
3	0002H	Set to Test mode	Active when set to 1
4	0003H	Set to automatic mode	Active when set to 1
5	0004H	Set to manual mode	Active when set to 1

Item	Address	Content	
1	0000H	Start generator	Active when set to 1
2	0001H	Stop generator	Active when set to 1

9 Appendix

9.3.5 Function #5 Remote coils Map

Item	Address	Content	
3	0002H	Set to Test mode	Active when set to 1
4	0003H	Set to automatic mode	Active when set to 1
5	0004H	Set to manual mode	Active when set to 1

10 Glossary and List of Abbreviations

CB	Circuit Breaker
CT	Current Transformer
DI	Discrete Input
DO	Discrete (Relay) Output
ECU	Engine Control Unit
FMI	Failure Mode Indicator
GCB	Generator Circuit Breaker
GOV	(speed) Governor; rpm regulator
HMI	Human Machine Interface e.g., a front panel with display and buttons for interaction
I	Current
MCB	Mains Circuit Breaker
MPU	Magnetic Pickup Unit
N.C.	Normally Closed (break) contact
N.O.	Normally Open (make) contact
NC	Neutral Contactor
OC	Occurrence Count
Operation	In (general) operation. State when the genset is running according to the selected mode, all parameters are in allowed values and ranges, and without OPEN requests or alarms. Somehow "waiting for next occurrence".
P	Real power
P/N	Part Number
PF	Power Factor
PT	Potential (Voltage) Transformer
Q	Reactive power
S	Apparent power
S/N	Serial Number
SPN	Suspect Parameter Number
V	Voltage

Index

A

Alarms

Classes	86
Shutdown Alarms	87

C

Commissioning	74
Configuration	30
Contact person	13
Customer Service	13

D

Data Telegrams	89
----------------------	----

F

Front Panel	30
Functions	16

H

HMI	58
-----------	----

I

Installation	21
Intended use	13
Interfaces	28, 75

K

Keys	31
------------	----

L

Language	36
----------------	----

M

Mounting 21

O

Operation 30

Operation Modes 67

P

Personnel 14

Protocols 75

S

Service 13

Symbols

 in the instructions 11

System Overview 16

T

Technical Specifications 81

ToolKit-SC 29, 36

Trouble Shooting 88

U

Use 13

W

Warnings 86

Warranty 13

Wiring 21



Woodward GmbH
Handwerkstraße 29 — 70565 Stuttgart — Germany
Phone +49 (0) 711 789 54-510
Fax +49 (0) 711 789 54-101
marketing_pg@woodward.com